

Progressive lubrication systems

Product catalogue



Table of contents

Two leading brands	4	Overview of metering devices	87
Lubricants suitable for lubrication systems	5	SSVM	88
System description	6	SSVD	90
Applications	7	SSVDL	94
Overview of pumps and pump units	9	SPVS	96
P 205	12	VPB	98
P 203	14	SSV	100
P 223/P 233	18	SSVL	104
KFG	22	VPK	106
KFA	26	VP	110
QLS 311 SSV	28	PSG1	114
QLS 301 SSV	30	PSG2	116
QLS 401 SSV	32	PSG3	118
QLS 401 SSV DV	34	UV	120
QLS 421 SSV	36	MC ² -HP	122
P 502	38	XL	124
P 603 M	42	LP2	126
P 623 M	44	Overview of control units	129
P 653 M	46	LMC 101	130
ZPU 01/02	48	LMC 2	131
EDL1	50	LMC 301	132
E-PUMP	52	EOT-2	134
PPU-5/PPU-35	54	IG 502-2E +	135
87214	56	IGZ / EXZT	136
87200/87216/130179	58	ST-102	138
PP/PPG	60	ST-1240-GRAPH-4	139
PFP-23-2/PFP-23-22	62	ST-2240-LUB	140
MPB	64	LRM 2	142
87212	66	Overview of monitoring devices	145
87202	68	HCC	146
PHU-5/PHU-35	70	SmartPlug lubrication control	148
PFH-23-2/PFH-23-22	72	Universal piston detector	149
MCLP	74	SP/SFE30	150
HP/HPG	76	EWT2A	151
HP-500W/HP-500W-SSV	78	234-11145-3/4/5/9	152
PF-VPBM/169-000-146	80	234-10825-8	153
HJ 2	82	Index	154
PF-23-2/PF-23-22	84		

Navigation

Introduction 2

Pumps and pump units 9

Metering devices 87

Control units. 129

Monitoring devices. 145

Two leading brands



One global leader

SKF and Lincoln have joined forces to provide you with the world's most complete portfolio of innovative lubrication solutions – from manual lubricators and tools, to the most advanced centralized and automatic lubrication systems available.

In addition to traditional lubrication products and systems, we offer customized solutions for many industries such as pulp and paper, steel, mining, agriculture, marine, rail, wind, construction, machine tool and automotive. SKF engineering and technical specialists partner with OEMs and end-users to develop system solutions based on customer requirements. We also offer a variety of control and monitoring equipment for ease of use and to help ensure proper lubrication.

Both SKF and Lincoln systems are available through our global network of lubrication experts, offering you world-class installation and ongoing support on a local level – today and into the future. With the power of this network, and more than 200 years of combined friction management experience, we can help you improve machine reliability, reduce maintenance, increase productivity, enhance safety and optimise manpower resources.

Lubricants suitable for lubrication systems

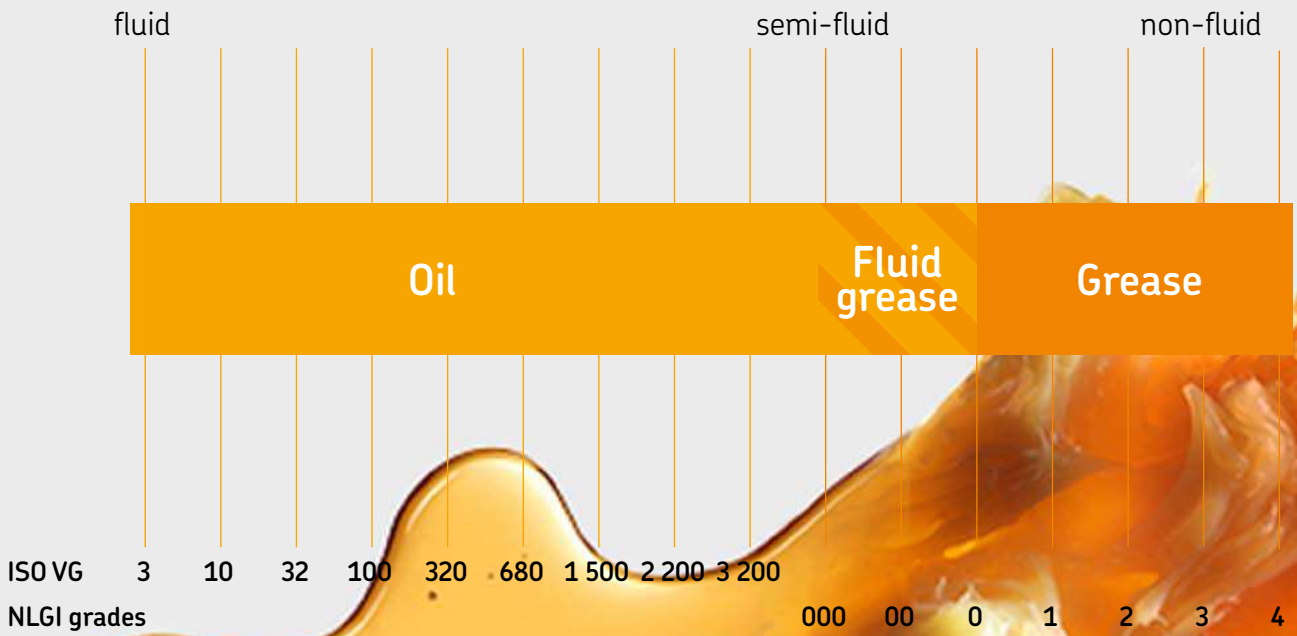

Oil and fluid grease

The viscosity is an expression of a fluid's internal friction. Oils are classified in ISO VG viscosity classes from 2 to 3 200. NLGI grade 000, 00 and 0 greases are called fluid greases. Different types of oils are available, including mineral oils, organic oils and synthetic oils. A compatibility check is recommended prior to using any oil with SKF lubrication systems.



Grease

Greases are consistent lubricants (NLGI grade 1–6). They are soft to hard, triple-component mixtures of a base oil as the lubricating fluid, a thickening agent and additives. In most instances, greases of NLGI grade 1 up to 3 are suitable for use in a lubrication system. A compatibility check should be made prior to using any grease with SKF lubrication systems.



System video

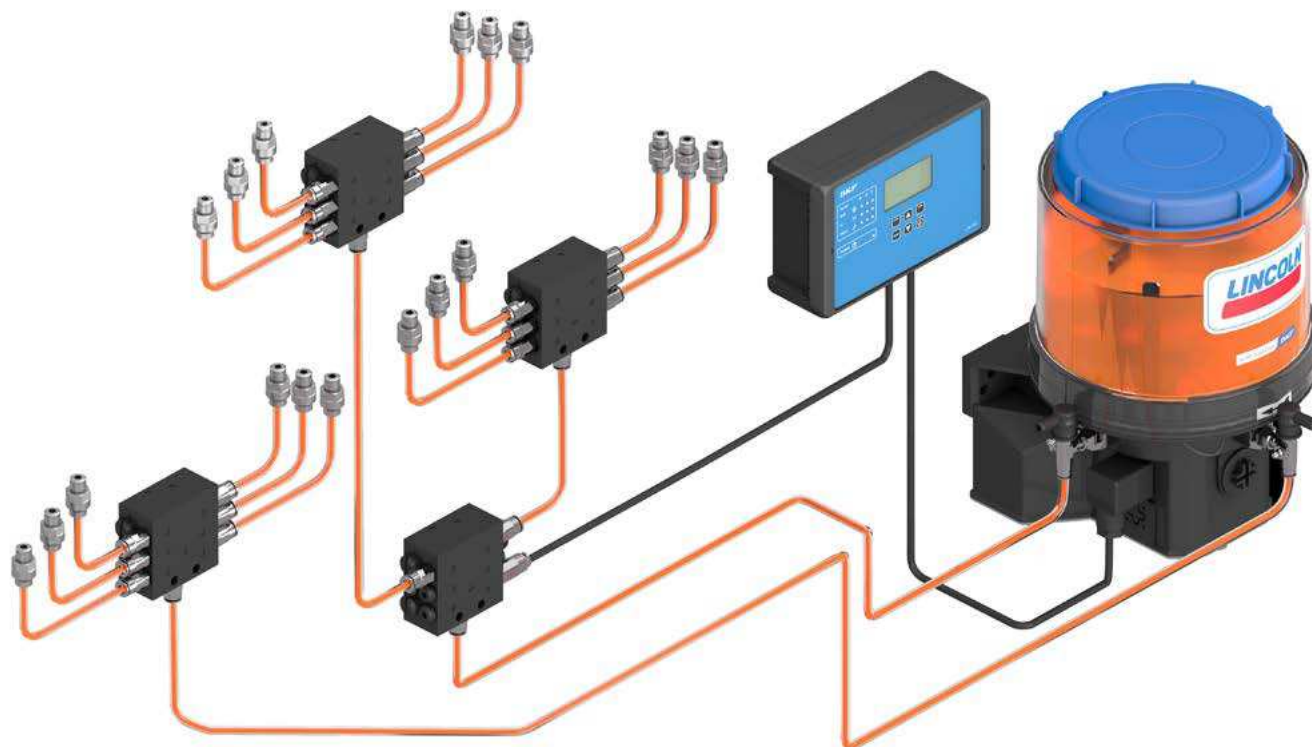

System description

SKF progressive systems, SKF ProFlex and Lincoln Quicklub, can be used on small- to medium sized machines with dispersed lubrication points that require varying lubrication quantities.

Progressive systems consist of a pump connected to at least one primary metering device. If needed, second level metering devices can be connected to the outlets of the primary metering device to increase the number of lubricated points, depending on operating pressure of the pump. The outlets of the primary and second level metering devices are connected via branch lines to the lubrication points of the machine. A third level of metering devices is not recommended. The pump supplies lubricant to the metering devices with pressure up to 550 bar (8 000 psi), depending on the pump model.

The metering devices split the lubricant into even or predefined amounts of lubricant, depending on metering device, that are positively displaced to the lubrication points or to the inlet of a connected secondary metering device. The lubricant amount provided by each outlet of the metering device depends on the type of metering device being used. SKF offers progressive systems that can dispense a precise, metered amount of lubricant to up to 150 lubrication points over distances of approximately 15 m (16 yd), depending on case values. For oil applications, even in connection with flow limiters we can cover distances over 100 m (110 yd), see also SKF Lincoln lubrication solutions portfolio brochure.

Oil Circulation Systems. SKF progressive systems provide continuous lubrication as long as the pump is in operation. Once the pump stops, the pistons of the progressive metering device will stop in their current positions. When the pump starts supplying lubricant again, the pistons will carry on where they left. Therefore, the progressive circuit of one outlet of the pump will stop when only one lubrication point is blocked. The blockage serves as a means of control and forces personnel to service the system. Only one outlet of a primary or a secondary metering device of one pump outlet can be monitored visually or electrically, depending on the chosen metering device.

For planning a lubrication system, conditions the system will be used in need to be determined first. The number of lube points, back pressures at the lube points, operating temperature range, lubricant, the feed pump's drive energy, control and monitoring etc. need to be defined correctly. Attention to information on bearing or lube point information need to be paid too. The sum of all the quantities metered out by the system's metering devices needs to be completed by safety margin and expansion and compressibility loss. SKF application engineers as well as SKF sales partners and distributors are experts in systems laying out lubrication according to all these specifications. A lubrication system laid out by SKF and partners ensures the supply of the correct amount of lubricant at the best time to lubricate. This reduces wear and it avoids pollution caused by over-lubrication.



Applications

The systems are suitable for a variety of applications including: construction machines (concrete pumps, mortar pumps, loaders, excavators, trenchers); on-road trucks (snow removal, waste press); buses; agricultural machines (harvesters, balers, manure spreaders, sugar cane loaders); wood reclaimers; and material handling (reach stackers, crane carts). In addition, progressive lubrication systems are suitable for use in asphalt mixing plants, wind turbine generators and food and beverage facilities (fillers, washing machines), reciprocating compressors in the Oil and Gas industry, among many others.

SKF progressive systems are reliable and operate effectively in harsh conditions (inclusive ATEX) with potentially high lubrication-point back pressure, dirty, wet or humid environments and low temperatures.



Overview of pumps and pump units

Electrically operated pump units										
Product	Function principle	Lubricant		Metering quantity		Reservoir		Operating pressure max.		Page
		oil	grease	per pump element						
		mm ² /s	NLGI	cm ³ /min	in ³ /min	l	gal	bar	psi	
P 205	Piston pump unit	40–1 500	up to 2	0,23–40,25	0.014–2.45	5–30	1.32–7.9	350	5 075	12
P 203	Piston pump unit	40–1 500	up to 2	0,7–4,0	0.042–0.244	2–15	0.53–4.0	350	5 075	14
P 223/P 233	Piston pump unit	40–1 500	up to 2	0,7–4,0	0.042–0.244	2–15	0.53–4.0	350	5 075	18
KFG	Piston pump unit	–	up to 2	0,8–5,0	0.049–0.305	2–20	0.53–5.28	300	4 350	22
KFA	Piston pump unit	–	up to 2	1,0–2,0	0.061–0.122	1	0.26	300	4 350	26
QLS 311 SSV	Piston pump unit with metering device	40–1 500	–	1,0	0.03	1; 2	0.26; 0.53	80	1 200	28
QLS 301 SSV	Piston pump unit with metering device	–	up to 2	1,0	0.06	1	0.26	205	3 000	30
QLS 401 SSV	Piston pump unit with metering device	–	up to 2	1,0	0.06	1; 2	0.26–0.53	205	3 000	32
QLS 401 SSV DV	Piston pump unit with metering device	–	up to 2	1,0	0.06	1; 2	0.26–0.53	205	3 000	34
QLS 421 SSV	Piston pump unit with metering device	–	up to 2	1,0	0.06	1; 2	0.26–0.53	205	3 000	36
P 502	Piston pump unit	–	up to 2	1,0–2,4	0.06–0.15	1	0.26	270	4 000	38
P 603 M	Piston pump unit	–	up to 2	4,0–12,0	0.24–0.73	4–100	1.05–26.4	350	5 075	42
P 623 M	Piston pump unit	–	up to 2	4,0–12,0	0.24–0.73	4–20	1.05–5.28	300	4 351	44
P 653 M	Piston pump unit	–	up to 2	8,0–24,0	0.48–1.46	4–100	1.05–26.4	350	5 075	46
ZPU 01/02	Piston pump unit	20–1 500	up to 3	13,3–53,3	0.83–3.25	10–30	2.64–7.92	350	5 075	48
EDL 1	Pressure booster pump	–	up to 2	0,5–1,0	0.03–0.06	–	–	280	4 015	50
				cm ³ /min	in ³ /min	kg	lb	bar	psi	
E-PUMP	Barrel pump unit	40–1 000	up to 2	55	3.35	18–180	40–400	240	3 480	52

Air operated pump units										
Product	Function principle	Lubricant		Metering quantity		Reservoir		Operating pressure max.		Page
		oil	grease	cm ³ /stroke	in ³ /stroke	l	gal	bar	psi	
		mm ² /s	NLGI	cm ³ /stroke	in ³ /stroke	l	gal	bar	psi	
PPU-5	Piston pump unit	40–1 500	up to 2	0,10–0,50	0.006–0.030	2,5; 5,0	0.66; 1.32	160	2 320	54
PPU-35	Piston pump unit	40–1 500	up to 2	0,70–3,50	0.042–0.210	2,5; 5,0	0.66; 1.32	160	2 320	54
87 214	Piston pump	40–1 500	up to 2	0,164–0,980	0.010–0.060	–	–	14	200	56
87 216	Piston pump	40–1 500	up to 2	0,010–0,050	0.010–0.050	–	–	–	–	58
87 200	Piston pump	40–1 500	up to 2	0,041–0,164	0.025–0.100	–	–	–	–	
PPG	Piston pump unit	–	up to 2	0,2	0.012	0,4; 1,5	0.1; 0.4	300	4 350	60
PP	Piston pump unit	–	up to 2	2,6	0.158	1,5	0.4	300	4 350	60
PPF-23-22	Piston pump unit	–	up to 2	1,25 /port	0.076 /port	1,5	0.4	190	2 755	62
PPF-23-2	Piston pump unit	–	up to 2	2,50 /port	0.150 /port	1,5	0.4	190	2 755	62
MPB	Barrel pump unit	20–10 000	up to 2	6,1	0.37	18, 50, 180	40, 120, 400	300	4 350	64



Overview of progressive pump units

Hydraulically operated pumps and pump units

Product	Function principle	Lubricant	grease	Metering quantity		Reservoir		Operating pressure max.		Page
		oil		cm ³ /stroke	in ³ /stroke	l	gal	bar	psi	
		mm ² /s	NLGI							
87 212	Piston pump (unit)	40–1 500	up to 2	0,164–0,98	0.01–0.06	–	–	68	1 000	66
87 202	Piston pump (unit)	40–1 500	up to 2	0,41–1,64	0.025–0.10	–	–	138	2 000	68
PHU-5	Piston pump unit	40–1 500	up to 2	0,1–0,5	0.006–0.030	2,5; 5,0	0.66; 1.32	160	2 320	70
PHU-35	Piston pump unit	40–1 500	up to 2	0,7–3,5	0.042–0.210	2,5; 5,0	0.66; 1.32	160	2 320	70
PFH-23-22	Piston pump unit	–	up to 2	1,25 /port	0.076 /port	1,5	0.4	190	2 755	72
PFH-23-2	Piston pump unit	–	up to 2	2,50 /port	0.150 /port	1,5	0.4	190	2 755	72

Free shaft-end pump 1)

Product	Function principle	Lubricant	grease	Pump head	Metering quantity		Operating pressure max.		Page
		oil			mm	cm ³ /min	in ³ /min	bar	
		mm ² /s	NLGI						
MCLP	Piston pump	20–1 500	–	7 or 10	0,44–440	0.027–26.91	555	8 000	74

Manually operated pumps and pumps units

Product	Function principle	Lubricant	grease	Metering quantity		Reservoir		Operating pressure max.		Page
		oil		cm ³ /stroke	in ³ /stroke	l	gal	bar	psi	
		mm ² /s	NLGI							
HP / HPG	Piston pump unit	–	up to 2	0,2; 1,6 / SSV outlet	0.012; 0.098 / SSV outlet	0,4–1,5	0.11–0.4	250	3 625	76
HP-500-SSV	Piston pump unit	–	up to 2	0,2 /SSV outlet	0.012 /SSV outlet	0,4–0,5	0.11–0.13	400	5 800	78
HP-500W	Piston pump unit	–	up to 2	1,5	0.09	0,4–0,5	0.11–0.13	400	5 800	78
169-000-146	Piston pump unit	–	up to 2	0,2; 2,0 / VPBM outlet	0.012; 0.12 / VPBM outlet	0,4	0.11	400	5 800	80
PF-VPBM	Piston pump unit	–	up to 2	2,0	0.12	0,4	0.11	400	5 800	80
HJ 2	Piston pump unit	150–1 500	up to 2	1–2	0.06–0.12	3 l	0.79	300	4 350	82
PF-23-22	Piston pump unit	–	up to 2	1,25	0.076	1,5 l	0.4	100	1 450	84
PF-23-2	Piston pump unit	–	up to 2	2,5	0.15	1,5 l	0.4	100	1 450	84

Pump unit

P 205



Product description

The P 205 high-pressure, multi-line pump can supply lubricant directly to lubrication points or can be used as a centralized lubrication pump in large-sized progressive systems. It can drive up to five elements, which are available in varying sizes for optimum adjustability. The pump's drive and eccentric shaft design, high-efficiency worm gear, minimal number of parts and multi-range motor provide several advantages. P 205 pumps are available with a three-phase flange mount and multi-range motor or with a free shaft end for use with other motors. Various gear ratios and reservoir sizes with or without level control are offered.

Features and benefits

- Durable, versatile and reliable pump series
- Suitable for grease or oil
- Designed for continual lubrication of machines and systems operating in harsh environments
- Broad range of output options
- Modular design and easy maintenance

Applications

- Stationary machines with a high lubricant consumption
- Turbines in hydro-electric power plants
- Needling machines
- Screens and crushers in quarries
- Material handling equipment

Technical data

Function principle	electrically operated piston pump
Metering quantity	oil: 0,23–40,25 cm ³ /min 0,014–2,45 in ³ /min grease: 0,23–28,75 cm ³ /min 0,014–1,75 in ³ /min
Outlets	1 to 5
Lubricant	oil: viscosity 40–1 500 mm ² /s grease: up to NLGI 2
Operating pressure	max. 350 bar, 5 075 psi
Operating temperature	–20 to +40 °C, –4 to +104 °F
Protection class	IP 55
Materials	steel plate or plastic, depending on reservoir
Reservoir ¹⁾	plastic: 4 and 8 kg, 8,8 and 17,6 lb steel: 5, 10 and 30 kg; 11; 22 and 66 lb
Line connection	G 1/4
Drive speed main shaft	grease: 25 min ⁻¹ , oil: 35 min ⁻¹
Electrical connections	380–420 V AC/50 Hz, 440–480 V AC/60 Hz 500 V AC/50Hz
Dimensions	depending on the model min. 406 × 280 × 230 mm max. 507 × 365 × 300 mm min. 160 × 110 × 91 in max. 200 × 144 × 118 in
Mounting position	vertical
Options	several different level switches; ATEX versions

¹⁾ valid for $\rho=1 \text{ kg/dm}^3$



NOTE

For further technical information, technical drawings, accessories, spare parts or product function descriptions, see the following publication available on SKF.com/lubrication:

13651

Pump unit

P 205

Identification code	P	205	-			-			-			-		
Product series	P 205													
Drive														
M = AC flange gear motor F = free shaft end														
Gear ratio														
280 = 280:1 700 = 700:1 070 = 70:1														
Reservoir														
4 = plastic, 4 l, 1.05 gal 8 = plastic, 8 l, 2.11 gal 5 = steel plate, 5 l, 1.32 gal 10 = steel plate, 10 l, 2.64 gal 30 = steel plate, 30 l, 7.93 gal														
Reservoir design														
N = without level control XY = for grease and oil XL = for grease with low level control BU = with level control (ultrasonic sensor for two switching points, low- and high-level)														
Pump elements; define max. 5 elements (f.i. 4 K6 = 4K6, ...)														
K5 = piston ø 5 mm, output per stroke: 0,11 cm ³ , 0.0067 in ³ K6 = piston ø 6 mm, output per stroke: 0,16 cm ³ , 0.0098 in ³ K7 = piston ø 7 mm, output per stroke: 0,23 cm ³ , 0.014 in ³ KR = adjustable output, piston ø 7 mm, output per stroke: 0,04-0,18 cm ³ , 0.0024-0.011 in ³														
Supplements to motor designation														
320 - 420, 440 - 480 = multi-range motor for nominal supply voltage, 380-420 V AC/50 Hz, 440-480 V AC/60 Hz 500 = single-range motor for nominal supply voltage, 500 V/50 Hz 000 = pump without motor, with coupling flange														

P205 pump elements

Order number	Description	Metering quantity	
		cm ³ /stroke	in ³ /stroke
600-26875-2	pump element K5	0,11	0.0067
600-26876-2	pump element K6	0,16	0.0098
600-26877-2	pump element K7	0,23	0.014
655-28716-1	adjustable pump element KR (7)	0,04-0,18	0.0024-0.011
303-19285-1	closing screw ¹⁾		

¹⁾ for outlet port instead of a pump element

Pressure-relief valve and filling connectors

Order number	Description
624-29056-1	pressure-relief valve, 350 bar, G 1/4 D 6 for tube ø 6 mm OD
624-29054-1	pressure-relief valve, 350 bar, G 1/4 D 8 for tube ø 8 mm OD
304-17571-1	filling connector G 1/4 female ¹⁾
304-17574-1	filling connector G 1/2 female ¹⁾

¹⁾ filling connector fits for vacant outlet ports

Pump unit

P 203



Description

The P 203 lubrication pump is versatile, compact and economical and can supply up to 150 lubrication points, depending on the line length. It consists of a housing with integrated motor, reservoir with stirring paddle, pump element with pressure-relief valve, filling nipple and electrical connection parts. This powerful pump can drive up to three pump elements and can be equipped with a low-level control (with or without control board).

Features and benefits

- Optional control printed circuit boards with different operating settings
- Range of reservoir types offered
- For DC or AC applications
- Variety of pumping elements for different output available

Applications

- Mobile applications
- Wheel loaders
- Excavators
- Small- and medium-sized machinery
- General industries
- Combines, balers, forage harvesters

Technical data

Function principle	electrically operated piston pump
Operating temperature	
V DC:	-40 to +70 °C; -40 to +158 °F
V AC:	-25 to +70 °C; -13 to +158 °F
Operating pressure	350 bar; 5 075 psi
Lubricant	grease: up to NLGI 2 oil: viscosity 40–1 500 mm ² /s
Outlets	up to 3
Metering quantity	depending on pump element: 0,7–4,0 cm ³ /min per outlet 0,042–0,244 in ³ /min per outlet
Reservoir	2; 4; 8; 11 and 15 l 0,53, 1,05, 2,11; 2,09 and 3,96 gal
Connection main line	G 1/4
Operating voltage	12/24 V DC, 110–260 V AC; 50/60 Hz
Dimensions	min. 211 × 224 × 287 mm max. 211 × 250 × 774 mm min. 8.31 × 8.82 × 11.29 in max. 8.31 × 9.84 × 30.47 in
Protection class	IP6K9K
Mounting position	upright, with follower plate any



NOTE

Further technical information, technical drawings, accessories, spare parts or product function descriptions are available on SKF.com/lubrication:

12401 EN



CAD: skf-lubrication.partcommunity.com

Pump unit

P 203

Identification code	P203 - - - - - - - - - - - - - - - -											
Product series	P203 = model											
Corrosions resistance	_ = standard (C3) X = seawater protection (C5M)											
Accreditation	U = UL approval E = KBA approval D = UL/CSA/KBA approval											
Reservoir size	_2 = 2 l; 0.52 gal 11 = 11 l; 2.90 gal _4 = 4 l; 1.06 gal 15 = 15 l; 3.96 gal _8 = 8 l; 2.11 gal											
Lubricant	X = grease Y = oil											
Fill level monitoring	N = normal version C = low level signal (as normally closed) L = low level signal P = high-, low level and prewarning signal B = high- and low level signal											
Reservoir type ¹⁾	BO = filling from top FL = flat reservoir (2l only) BA = filling from top, lockable F = with follower plate											
Pump elements	0 = no pump element B = 2,0 cm ³ /min; 0.12 in ³ /min, with bypass-check valve 5 = 2,0 cm ³ /min; 0.12 in ³ /min C = 4,0 cm ³ /min; 0.24 in ³ /min ²⁾ 6 = 2,8 cm ³ /min; 0.17 in ³ /min R = adjustable 0,7–3,0 cm ³ /min, 0.042–0.18 in ³ /min 7 = 4,0 cm ³ /min; 0.24 in ³ /min											
Power supply	12 = 12 V DC, with square plug, bayonet plug or M12 plug 24 = 24 V DC, with square plug, bayonet plug or M12 plug AC = 110–260 V AC, ±10%, 50/60 Hz ±5%, with square plug ³⁾											
Electrical connection ⁴⁾ (power supply, mandatory for position 1 or 2)	Position 1 00 = no plug, no socket, no cable D0 = square plug, no socket, no cable ⁵⁾ D1 = square plug, with socket, without cable (with PcB) ⁵⁾ 11 = square plug, with socket, without cable (without PcB) Position 2 00 = no plug, no socket, no cable 20 = M12 plug, no socket, no cable PF = bayonet plug, 7/5 pole and bayonet socket, 7/5 wire, with cable ⁶⁾ RG = bayonet plug, 7/6 pole and bayonet socket, 7/6 wire, with cable ⁶⁾ TG = bayonet plug, 7/7 pole and bayonet socket, 7/7 wire, with cable ⁶⁾ version for US market Position 3 00 = no plug, no socket, no cable F2 = square plug, with socket, no cable (with PcB) ⁵⁾ FB = square plug, with socket, with cable (with PcB) ⁵⁾ ⁶⁾ G2 = square plug, with socket, no cable (without PcB) GB = square plug, with socket, with cable (without PcB) ⁶⁾ Position 4 00 = no plug, no socket, no cable NO = bayonet plug, 4/4 pole, no socket, no cable NK = bayonet plug, 4/4 pole, bayonet socket, 4/4 wire, with cable ⁶⁾											
Control boards	- = without control board V10–V13 = control board with variably adjustable pause and lubricating time (pin 15 and 30 internally bridged) V20–V23 = control board with variably adjustable pause and lubricating time M08–M23 = control board with microprocessor control (different setting variants, monitored systems) MS8 = control board with microprocessor control (different setting variants, monitored systems) for US market H = control board for trailers and semi-trailers											
Lubricant priming	A = pump prefilled partially with standard grease (NLGI 2) S = pump filled with customer specific grease Z = pump without lubricant (default for oil pumps)											

1

2

3



1

2

3

4

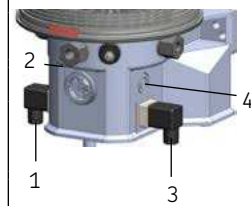

¹⁾ high-/low-level control can not be combined with the integrated control P.C.B.

²⁾ designation for pump elements for supplying of chisel paste (c=chisel)

³⁾ equipment described in separate documentation

⁴⁾ further electrical connections available on request

⁵⁾ only for 110–260 V AC power supply

⁶⁾ cable 10 m (32 ft)

Accessories

P 203

Pump elements¹⁾

Order number	Description	Material	Piston		Nominal output ⁶⁾	
			Ø mm		cm ³ /min	in ³ /min
600-78018-1	pump element L5 ²⁾	steel, gasnitro-carburized	5		0,5	0.03
600-26875-2	pump element K5	steel, gasnitro-carburized	5		1,8	0.11
600-26876-2	pump element K6	steel, gasnitro-carburized	6		2,8	0.17
600-26877-2	pump element K7	steel, gasnitro-carburized	7		4	0.24
655-28716-1	pump element KR	steel, gasnitro-carburized	7		0,7-3,3	0.04-0.02
600-28750-1 ³⁾	pump element C7	steel, gasnitro-carburized	7		4	0.24
600-29303-1	pump element K5 DN	steel, nickel-plated ⁵⁾	5		1,8	0.11
600-29304-1	pump element K6 DN	steel, nickel-plated ⁵⁾	6		2,8	0.17
600-29305-1	pump element K7 DN	steel, nickel-plated ⁵⁾	7		4	0.24
600-29185-1 ⁴⁾	pump element B7 DN	steel, nickel-plated ⁵⁾	7		1,8	0.11

1) Male thread M 22 × 1,5; female thread G 1/4

2) L5 only permitted for application of NLGI 00 lubrication grease

3) Pump element for supplying of chisel paste

4) With bypass check valve

5) For application in beverage industry

6) The stated nominal outputs per minute and pump element refer to NLGI 2 lubrication greases at an ambient temperature of + 20 °C [68 °F] and a pressure of 100 bar [1450 psi] at the outlet of the pump element. Deviating operating conditions or deviating pump configuration result in a changed motor speed of 20 rpm and thus in a change of the output per time unit.

Return-line connector with filler fitting, screw type

Order number	Description	Filling nipple	Thread	Tube		Reservoir
				Ø mm		
504-30698-1	return-line connector	straight	R1/4	6		2 l
504-36071-5	return-line connector	straight, with adapter	R1/4	6		2 l flat-type, 4 and 8 l
504-36071-6	return-line connector-line	90°	R1/4	6		2 l flat-type, 4 and 8 l
304-16543-1	adapter		M 22 × 1,5 × G 1/4			

Reservoir conversion sets

Order number	Designation
Conversion set from 2 to 4 l reservoir:	
544-32787-1	2XN to 4XN
544-32022-1	2XN to 4XNBO
Conversion set from 2 to 8 l reservoir:	
544-32788-1	2XN to 8XN
544-32023-1	2XN to 8XNBO

Quick filling connector

Order number	Description	Connection	Filter
544-36961-1	filler fitting with protective cap	G 1/4	-
504-32125-1	coupling plug with protective cap	G 1/4	-
233-10765-3	protective cap; for replacement	G 1/4	-
540-36753-5	filler fitting assembly	M22 × 1,5	•
540-31800-1	filler fitting	M22 × 1,5	•
504-36071-7	filler fitting	M22 × 1,5	-

Fuse holder with fuse

Order number	Description	Current load
237-13321-8	fuse holder	5 A
237-13426-1	fuse holder	8 A

Bracket for fixing pump and main metering device

Order number	Description
307-19644-1	bracket P203

Accessories

P 203

Pressure relief valves

Order number	Designation	Description	Relief pressure		Connection pressure line
			bar	psi	
624-28891-1	SVTE-200-1/4-D6	pressure relief valve (PRV)	200	2 900	screw type fitting D6
624-28894-1	SVTE-350-1/4-D6	PRV with emergency lubrication fitting, left-hand	350	5 075	screw type fitting D6
624-28896-1	SVTE-350-1/4-D6+NIP00L	PRV with emergency lubrication fitting, right-hand	350	5 075	screw type fitting D6
624-28897-1	SVTE-350-1/4-D6+NIP00R	PRV	350	5 075	screw type fitting D6
624-28895-1	SVTE-350-1/4-D8	PRV	350	5 075	screw type fitting D8
624-28861-1	SVTSV-200-R 1/4-6	PRV with emergency lubrication fitting, right-hand	200	2 900	push-in type D6
624-28858-1	SVTSV-350-R 1/4-6	PRV with emergency lubrication fitting, left-hand	350	5 075	push-in type D6
624-28860-1	SVTSV-350-R 1/4-6	PRV	350	5 075	push-in type D6
624-28867-1	SVTSV-350-R 1/4-6	PRV	350	5 075	push-in type D6
624-28859-1	SVTSV-270-R 1/4-1/8NPTF+NIP00R	PRV with emergency lubrication fitting, right-hand	270	3 915	thread 1/8 NPT female
226-14105-5	S2520-1/4-1/4-25 nipple	PRV adapter for connection of 2 l flat-type or 4 and 8 l reservoir			
624-29087-1	SVS-200-6-1/4-6	PRV kit with grease return to the reservoir	200	2 900	push-in type D6
624-28931-1	SVS-350-6-1/4-6	PRV kit with grease return to the reservoir	350	5 075	push-in type D6
524-32231-1	redesign-kit: grease return fitting for SVTSV+SVTE	grease return fitting for existing pressure relief valve	–	–	–
624-29426-1	pressure gauge	pressure gauge 0-400 bar with PRV SVKSV-350-1/4-D6	350	5 075	

Valve insert for pressure relief valves as replacement

Order number	Description	Relief pressure	
		bar	psi
235-14343-3	valve insert	350	5 075
235-14343-2	valve insert	270	3 915
235-14343-7	valve insert	250	3 625
235-14343-1	valve insert	200	2 900
235-14343-5	valve insert	120	1 740
235-14343-4	valve insert	80	1 160

Push-button illuminated

Order number	Description	Voltage	Light
664-85388-8	round	12/24 VDC	green
664-85388-9	round	12/24 VDC	red
664-85421-9	round	12/24 VDC	yellow
236-10280-6	rectangular	24 VDC	green

Connection socket and cable ¹⁾

Order number	Description	Cable		Protection class
		m	ft	
544-32850-1	connection socket with gasket and screw, black	–	–	IP65
544-33843-1	connection socket with gasket and screw, grey	–	–	IP65
664-36862-8	connection cable with connection socket, black	6	20	IP67
664-36078-7	connection cable with connection socket, black	10	30	IP67
664-36078-9	connection cable with connection socket, grey	10	30	IP67
664-36862-2	connection cable ADR with connection socket, grey	10	30	IP65
664-36862-1	connection cable ADR with connection socket, black	10	30	IP65
664-34167-2	connection cable with bayonet socket (7/5 pole)	10	30	IP 6K9K
664-34428-3	connection cable with bayonet socket (7/7 pole)	10	30	IP 6K9K
664-34167-6	connection cable with bayonet socket (4/3 pole)	10	30	IP 6K9K
664-34167-9	connection cable with bayonet socket (4/4 pole)	10	30	IP 6K9K

¹⁾ The type of connection sockets and cable depend on the equipment of the pump. Please refer to the assembly instruction of the respective pump.

Pump unit

P 223/P 233



Description

Similar to the P 203 series, the P 223/233 pumps feature an integrated control printed circuit board (P.C.B.) with metering device monitoring and can drive up to three pump elements. The P 233 provides supplementary Datalogger function for data transfer to Quickdata 2.0 diagnostic software. Versatile, compact and economical, the P 233 pump is enhanced with low-level control, printed circuit board MDF01/02 with attached Datalogger module and a keypad with display.

Features and benefits

- Datalogger P 233 shows system settings and events including general data, pumping times, programming, operating times, malfunction and low-level indication
- Using Quickdata 2.0 diagnostic software, data can be read out via laptop and infrared interface

Applications

- Mobile applications
- Track tamping machines
- Stationary systems
- Vehicles and construction machines

Technical data

Function principle	electrically operated piston pump
Operating temperature	-25 to +70 °C; -13 to +158 °F
Operating pressure	350 bar; 5 075 psi
Lubricant	grease: up to NLGI 2 oil: viscosity 40–1 500 mm ² /s
Outlets	up to 3
Metering quantity	depending on pump element; per outlet: 0,7–4,0 cm ³ /min; 0,042–0,24 in ³ /min
Reservoir	2, 4, 8, and 15 l; 0,53, 1,05, 2,11 and 3,96 gal
Connection main line	G 1/4
Operating voltage	12/24 V DC; 110/240 V AC (±10%); 50/60 Hz
Protection class	IP 6K9K
Dimensions	min. 230 × 224 × 367 mm max. 230 × 250 × 729 mm min. 9.06 × 8.82 × 14.45 in max. 9.06 × 9.84 × 28.70 in
Mounting position	any
with follower plate	any
without follower plate	upright

 NOTE

Further technical information, technical drawings, accessories, spare parts or product function descriptions are available on SKF.com/lubrication

Accessories

P 223/P 233

Pump elements¹⁾

Order number	Description	Material	Piston	Nominal output ⁶⁾	
			Ø mm	cm ³ /min	in ³ /min
600-78018-1	pump element L5 ²⁾	steel, gasnitro-carburized	5	0,5	0.03
600-26875-2	pump element K5	steel, gasnitro-carburized	5	1,8	0.11
600-26876-2	pump element K6	steel, gasnitro-carburized	6	2,8	0.17
600-26877-2	pump element K7	steel, gasnitro-carburized	7	4	0.24
655-28716-1	pump element KR	steel, gasnitro-carburized	7	0,7-3,3	0.04-0.02
600-28750-1 ³⁾	pump element C7	steel, gasnitro-carburized	7	4	0.24
600-29303-1	pump element K5 DN	steel, nickel-plated ⁵⁾	5	1,8	0.11
600-29304-1	pump element K6 DN	steel, nickel-plated ⁵⁾	6	2,8	0.17
600-29305-1	pump element K7 DN	steel, nickel-plated ⁵⁾	7	4	0.24
600-29185-1 ⁴⁾	pump element B7 DN	steel, nickel-plated ⁵⁾	7	1,8	0.11

1) male thread M 22 × 1,5; female thread G 1/4

2) L5 only permitted for application of NLGI 00 lubrication grease

3) pump element for supplying of chisel paste

4) with bypass check valve

5) for application in beverage industry

6) The stated nominal outputs per minute and pump element refer to NLGI 2 lubrication greases at an ambient temperature of + 20 °C [68 °F] and a pressure of 100 bar [1450 psi] at the outlet of the pump element. Deviating operating conditions or deviating pump configuration result in a changed motor speed of 20 rpm and thus in a change of the output per time unit.

Return-line connector with filler fitting, screw type

Order number	Description	Filling nipple	Thread	Tube	Reservoir
				Ø mm	
504-30698-1	return-line connector	straight	R1/4	6	2 l
504-36071-5	return-line connector	straight, with adapter	R1/4	6	2 l flat-type, 4 and 8 l
504-36071-6	return-line connector-line	90°	R1/4	6	2 l flat-type, 4 and 8 l
304-16543-1	adapter		M 22 × 1,5 × G 1/4		

Reservoir conversion sets

Order number	Designation
Reservoir conversion set 2l to 4l	
544-32787-1	2XN to 4XN
544-32022-1	2XN to 4XNBO
Reservoir conversion set 2l to 8l	
544-32788-1	2XN to 8XN
544-32023-1	2XN to 8XNBO

Quick filling connector

Order number	Description	Connection	Filter
544-36961-1	filler fitting with protective cap	G1/4	-
504-32125-1	coupling plug with protective cap	G1/4	-
233-10765-3	protective cap; for replacement	G1/4	-
540-36753-5	filler fitting assembly	M22 × 1,5	•
540-31800-1	filler fitting	M22 × 1,5	•
504-36071-7	filler fitting	M22 × 1,5	-

Fuse holder with fuse

Order number	Description	Current load
237-13321-8	fuse holder	5 A
237-13426-1	fuse holder	8 A

Bracket for fixing pump and main metering device

Order number	Description
307-19644-1	bracket P203

Accessories

P 223/P 233

Pressure relief valves

Order number	Designation	Relief pressure		Connection pressure line		Description
		bar	psi			
624-28891-1	SVTE-200-1/4-D6	200	2 900	screw type fitting D6		pressure relief valve (PRV)
624-28894-1	SVTE-350-1/4-D6	350	5 075	screw type fitting D6		PRV with emergency lubrication fitting, left-hand
624-28896-1	SVTE-350-1/4-D6+NIP00L	350	5 075	screw type fitting D6		PRV with emergency lubrication fitting, right-hand
624-28897-1	SVTE-350-1/4-D6+NIP00R	350	5 075	screw type fitting D6		PRV
624-28895-1	SVTE-350-1/4-D8	350	5 075	screw type fitting D8		PRV
624-28861-1	SVTSV-200-R 1/4-6	200	2 900	push-in type D6		PRV with emergency lubrication fitting, right-hand
624-28858-1	SVTSV-350-R 1/4-6	350	5 075	push-in type D6		PRV with emergency lubrication fitting, left-hand
624-28860-1	SVTSV-350-R 1/4-6	350	5 075	push-in type D6		PRV
624-28867-1	SVTSV-350-R 1/4-6	350	5 075	push-in type D6		PRV
624-28859-1	SVTSV-270-R 1/4-1/8NPTF+NIP00R	270	3 915	thread 1/8 NPT female		PRV with emergency lubrication fitting, right-hand
226-14105-5	S2520-1/4-1/4-25 nipple					PRV adapter for connection of 2 l flat-type or 4 and 8 l reservoir
624-29087-1	SVS-200-6-1/4-6	200	2 900	push-in type D6		PRV kit with grease return to the reservoir
624-28931-1	SVS-350-6-1/4-6	350	5 075	push-in type D6		PRV kit with grease return to the reservoir
524-32231-1	redesign-kit: grease return fitting for SVTSV+SVTE	-	-	-		grease return fitting for existing pressure relief valve
624-29426-1	pressure gauge	350	5 075			pressure gauge 0-400 bar with PRV SVKSV-350-1/4-D6

Valve insert for pressure relief valves as replacement

Order number	Description	Relief pressure	
		bar	psi
235-14343-3	valve insert	350	5 075
235-14343-2	valve insert	270	3 915
235-14343-7	valve insert	250	3 625
235-14343-1	valve insert	200	2 900
235-14343-5	valve insert	120	1 740
235-14343-4	valve insert	80	1 160

Push-button illuminated

Order number	Description	Voltage	Light
664-85388-8	round	12/24 VDC	green
664-85388-9	round	12/24 VDC	red
664-85421-9	round	12/24 VDC	yellow
236-10280-6	rectangular	24 VDC	green

Connection socket and cable ¹⁾

Order number	Description	Cable		Protection class
		m	ft	
544-32850-1	connection socket with gasket and screw, black	-	-	IP65
544-33843-1	connection socket with gasket and screw, grey	-	-	IP65
664-36862-8	connection cable with connection socket, black	6	20	IP67
664-36078-7	connection cable with connection socket, black	10	30	IP67
664-36078-9	connection cable with connection socket, grey	10	30	IP67
664-36862-2	connection cable ADR with connection socket, grey	10	30	IP65
664-36862-1	connection cable ADR with connection socket, black	10	30	IP65
664-34167-2	connection cable with bayonet socket (7/5 pole)	10	30	IP 6K9K
664-34428-3	connection cable with bayonet socket (7/7 pole)	10	30	IP 6K9K
664-34167-6	connection cable with bayonet socket (4/3 pole)	10	30	IP 6K9K
664-34167-9	connection cable with bayonet socket (4/4 pole)	10	30	IP 6K9K

¹⁾ The type of connection sockets and cable depend on the equipment of the pump. Please refer to the assembly instruction of the respective pump.

Pump unit

KFG



Description

The electrically operated KFG pump includes a drive shaft with an eccentric that drives up to three pump elements. It is comprised of four main components: housing with pump elements, reservoir with fill-level monitoring, internal control units and attachments. The pump is available in eight sizes and two variants for stationary use or with grease follower plate technology for utilization in any position. A variety of attachments permit reservoir filling, protect the pump (pressure-limitation valve) or enable the uncomplicated connection of the pump to a centralized lubrication system.

Features and benefits

- Durable and reliable components designed for extreme conditions (with positively driven pump elements)
- Versatile; can be used with single-line and progressive systems
- Fill-level and lubrication system monitoring
- Pin code protection of control unit available

Applications

- On- and off-road vehicles
- Renewable energy



NOTE

Further technical information, technical drawings, accessories, spare parts or product function descriptions are available on SKF.com/lubrication:

12649 EN



CAD: skf-lubrication.partcommunity.com

Technical data

Function principle	electrically operated piston pump
Operating temperature	-30 to +70 °C; -22 to +158 °F depending on type of pump element
Operating pressure	200 to 300 bar; 2 900 to 4 350 psi depending on type and size of pump element
Lubricant	grease NLGI 000 to 2, compatible with plastics, NBR elastomers, copper and copper alloys up to 3
Outlets	up to 3
Metering quantity	per pump element: 0,8; 1,3; 1,8; 2,5; 5,0 cm ³ /min 0.049, 0.079, 0.11, 0.15, 0.31 in ³ /min
Reservoir	2, 4, 6, 8, 10 ¹⁾ , 12 ¹⁾ , 15 ¹⁾ and 20 ¹⁾ kg 4.4, 8.8, 13.2, 17.6, 22 ¹⁾ , 26.5 ¹⁾ , 33 ¹⁾ and 44 ¹⁾ lbs
Material	aluminum-silicon cast alloy, PMMA, PA 6I
Connection	outlet pump element: M14 × 1,5 female thread
Power supply	12 V DC, 24 V DC, 230 or 90 to 264 V AC; (± 10%)
Dimensions	min. 266 × 208 × 229 mm max. 268 × 227 × 1,170 mm min. 10.47 × 8.19 × 9.01 in max. 10.55 × 8.93 × 46.06 in
Protection class	IP56
Mounting position with follower plate	any, installation possible also in rotating machines, e.g. wind turbines upright
without follower plate	

¹⁾ available on request

Accessories

KFG

Pump elements

Pump elements deliver the lubricant to the lubrication points or distributors through lubrication lines. Five pump elements for delivery rates of from 0,8 to 5,0 cm³/min are available for selection in two designs: with spring-return piston or with positively driven piston.

In many application instances, the pump element with spring-return piston is the correct choice. The pump element with positively driven piston was developed for use in extremely cold environments (up to -30 °C), or for high-viscosity lubricants. Up to three pump elements can be installed in the KFG pump unit. The possible attachment positions are located on the left, at the front and on the right on the pump housing. The lubricant outlet on the pump element has an M14x1.5 female thread for connecting lubrication lines or valves. If no pump element is installed, then the outlet of the pump housing is sealed with a screw.

KFG 1.U1



Pump elements KFG

Order number	Description	Nominal output ⁶⁾		Operating pressure max.	
		cm ³ /min	in ³ /min	bar	psi
KFG 1.U0	pump element with spring-return piston	5,0	0,31	200	2 900
KFG 1.U1	pump element with spring-return piston	2,5	0,15	300	4 850
KFG 1.U2	pump element with spring-return piston	1,8	0,11	300	4 850
KFG 1.U3	pump element with spring-return piston	1,3	0,079	300	4 850
KFG 1.U4	pump element with spring-return piston	0,8	0,049	300	4 850
KFG 1.U0-E	pump element with positively driven piston	5,0	0,31	200	2 900
KFG 1.U1-E	pump element with positively driven piston	2,5	0,15	300	4 850
KFG 1.U2-E	pump element with positively driven piston	1,8	0,11	300	4 850
KFG 1.U3-E	pump element with positively driven piston	1,3	0,079	300	4 850

Pressure relief valve

In order to prevent an excessive operating pressure in the system, a pivoted pressure relief valve should be attached. If the operating pressure exceeds the cracking pressure of the pressure restriction valve, then the valve will open and the lubricant can escape. The pressure restriction valve is used primarily in progressive systems. One can select among variants with SKF quick connectors, straight connector and with G1/4 female thread.

Pressure relief valve

Order number	Description	Operating pressure max.		Tube
		bar	psi	Ø mm
161-210-063	straight connector	200	2 900	8
161-210-061	SKF quick connector	200	2 900	8
161-210-065	straight connector	200	2 900	10
161-210-062	straight connector	200	2 900	12
161-210-012	straight connector	300	4 850	6
161-210-024	straight connector	300	4 850	8
161-210-066	straight connector	300	4 850	10
161-210-021	SKF quick connector	300	4 850	6
161-210-034	SKF quick connector	300	4 850	8
161-210-036	female thread G1/4	300	4 850	-

161-210-063



Accessories

KFG

Filling coupling set

One of the three lubricant outlets of the pump can, as an option, be equipped with one suitable filler socket instead of with one pump element, in order to fill the unit using a filling cylinder (cartridge).

A filling cylinder can also be optionally used to fill the pump unit through one of the lubricant outlets. To accomplish this, a filler socket must be configured in the order code in place of a lubricant outlet.



Filler coupling	
Order number	Description
169-000-174	filler coupling

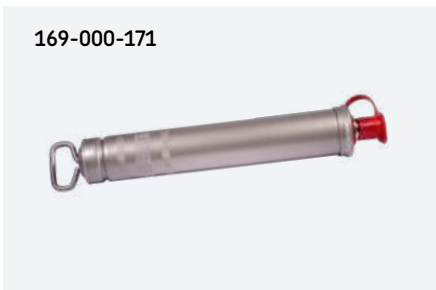

Filler cylinder	
Order number	Description
169-000-171	filler cylinder
24-9909-0241	filler socket G 1/4-kit

Filling coupling kit

As an alternative to a conical head nipple, the units for industrial or vehicle applications can also be equipped with a filler socket in order to fill it with a filling pump, e.g. the manual drum pump. A corresponding coupling socket and a hose socket must be mounted on the filling pump.



Filler coupling kit	
Order number	Description
24-9909-0244	KFG filler coupling kit G 1/4



Filler hose socket	
Order number	Description
857-760-007	hose socket Ø 13 mm
857-870-002	hose socket Ø 16 mm



Filler coupling socket	
Order number	Designation
995-001-500	coupling socket

Pump unit

KFA



Description

KFA series pumps include a maximum of two outlet ports to connect two independent lubrication circuits. A separate pump element is required for each outlet. Three pump elements with different delivery rates are available so that the volume of grease can be adjusted to individual circuit needs. This ensures that every lubrication point is supplied with an adequate amount of grease in each lubrication cycle. Model KFAS has an integrated IG502-2-1 control and monitoring unit that operates in a time- or load- (pulse) dependent mode, with or without monitoring..

Features and benefits

Integrated control system provides:

- Non-volatile memory with PIN-code protection
- Storage of residual interval, lubricating cycle and faults signals
- Saved data in event of a power failure
- Connection for external pushbutton and inductive cycle switch
- Interval and contact times can be set independently
- Fits in tight/small places

Applications

- Commercial vehicles
- Machine tools
- Printing industry



Technical data

Function principle	electrically operated piston pump
Operating temperature	-25 to +75 °C -13 to +167 °F
Operating pressure	300 bar; 4 350 psi
Lubricant	grease up to NLGI 2
Outlets	1 to 2
Metering quantity	1,0; 1,5; 2,0 cm ³ /min 0.061; 0.092; 0.122 in ³ /min
Reservoir	1 l; 0.26 gal
Connection main line	M14 × 1.5
Operating voltage	12 and 24 V DC; 115 V AC; (± 10%)
Protection class	IP 6K9K
Dimensions	216 × 150 × 234,5 mm 8.1 × 5.9 × 9.2 in
Mounting position	upright



NOTE

Further technical information, technical drawings, accessories, spare parts or product function descriptions are available on SKF.com/lubrication:

951-170-008, 12667-EN

Pump unit and accessories

KFA

Order information

Order number	Description applications	Monitoring		Control units		Voltages		
		level monitoring	cycle switch	extern	integrated	12 V DC	24 V DC	115 VAC
KFA1+912	vehicles	-	-	•	-	•	-	-
KFA1+924	vehicles	-	-	•	-	-	•	-
KFA1-W+912	vehicles	•	-	•	-	•	-	-
KFA1-W+924	vehicles	•	-	•	-	-	•	-
KFAS1+912	vehicles	-	-	-	•	•	-	-
KFAS1+924	vehicles	-	-	-	•	-	•	-
KFAS1-W+912	vehicles	•	-	-	•	•	-	-
KFAS1-W+924	vehicles	•	-	-	•	-	•	-
KFA1-M+924	industry	-	-	•	-	-	-	-
KFA1-M-W+924	industry	•	-	•	-	-	•	-
KFAS1-M+924	industry	-	-	-	•	-	•	-
KFAS1-M-Z+924	industry	-	•	-	-	-	•	-
KFAS1-M-W+924	industry	•	-	-	•	-	•	-
KFAS1-M-W-Z+924	industry	•	•	-	•	-	•	-
KFAS10+485	industry	-	-	-	•	-	-	•
KFAS10-W+485	industry	•	-	-	•	-	-	•

¹⁾ only pump; pump elements need to be ordered separately

KFA pump elements

Order number	Description	Metering quantity	
		cm ³ /min	in ³ /min
KFA1.U1	pump element	2,00	0.122
KFA1.U2	pump element	1,50	0.092
KFA1.U3	pump element	1,00	0.061

KFA1.U1



Cable kits

Order number	Description, applications
997-000-820	cable kit for pump KFA1, square type, 4-pins (12 m, 39 ft)
997-000-630	cable kit bayonet for pump KFAS1 and KFAS1-W, 7-pins, (12 m, 39 ft)
997-000-650	cable kit bayonet for pump KFAS1 and KFAS1-W, 7-pins, (16 m, 52 ft)

997-000-63



Pressure relief valve and connector

Order number	Description	Operating pressure		Tube Ø mm
		bar	psi	
161-210-016	pressure relief valve with T-connector	300	4 350	10
161-210-030	pressure relief valve with T-connector	200	2 900	10
161-210-031	pressure relief valve with T-connector	200	2 900	8
161-210-032	pressure relief valve with T-connector	200	2 900	6
161-210-040	pressure relief valve with T-connector	120	1 740	10
161-210-041	pressure relief valve with T-connector	120	1 740	8
161-210-042	pressure relief valve with T-connector	120	1 740	6
161-210-012	pressure relief valve with straight connector	300	4 350	6

161-210-016



Pump unit

QLS 311 SSV



Description

The QLS 311 pump is a monitored lubrication system with low-level control for a maximum of 18 lubrication points. Designed for use with standard high-pressure plastic tubing, the QLS family includes pumps with or without mounted SSV metering devices. An optional integrated controller for pause and lubrication times is available.

Features and benefits

- Internal lubricant return possible
- Integrated pressure-relief valves
- External programming via keypad
- System monitoring with display of faults
- Standard low-level control
- Suitable for VAC and V DC versions
- Protection: IP 6K9K, NEMA 4

Applications

- Machine tools
- Metal processing
- Chain lubrication
- Material handling
- Automotive industry
- Food processing
- Printing industry
- Farm machinery

Technical data

Function principle	electrically operated piston pump
Operating temperature	-25 to +70 °C; -13 to +158 °F
Operating pressure	80 bar; 1 200 psi
Lubricant	oil: 40–1 500 mm ² /s
Outlets	up to 18
Metering quantity	1,0 cm ³ /min; 0,06 in ³ /min
Reservoir	1, 2 l; 0,26; 0,53 gal
Connection main line via SSV:	see information for SSV
via connection block:	G 1/8 12/24 V DC; 120 and 230 VAC (± 10%)
Protection class	IP 6K9K
Dimensions	min. 237 × 215 × 230 mm min. 9.33 × 8.46 × 9.05 in max. 237 × 235 × 353 mm max. 9.33 × 9.25 × 13.89 in
Mounting position	upright



NOTE

Further technical information, technical drawings, accessories, spare parts or product function descriptions are available on SKF.com/lubrication.

Pump unit and accessories

QLS 311 SSV

Identification code	P	3	1	1											
Product design															
SSV Metering devices															
0 = external SSV 6, SSV 8 ¹⁾															
1 = external SSV 12, SSV 18 ¹⁾															
3 = SSV 6, rear-mounted															
4 = SSV 8, bottom only															
6 = SSV 12															
9 = SSV 18															
SSV metering device position															
0 = without external metering device															
1 = back, vertical order of lines															
2 = bottom, horizontal order of lines ²⁾															
Operating voltage															
2 = 12 V DC															
4 = 24 V DC															
6 = 120 V AC, only with control P.C.B.															
8 = 230 V AC, only with control P.C.B.															
Reservoir with low level control															
1 = 1 l; 0.26 gal															
2 = 2 l; 0.53 gal															
Connections															
0 = 1A – 1 connector, square-type plug, left, power supply															
1 = 2A – 2 connectors, square-type plug, 1 connector left, power supply, 1 connector right, fault indication															
2 = 1A – 1 connector, bayonet, left, power supply, fault indication, only for V DC application															
Connection socket design															
1 = square plug, design. For industrial applications ³⁾															
5 = bayonet plug 4-pole design, only V DC application. For vehicles ⁴⁾															
Electrical connector types															
1 = with socket, without cable ³⁾															
5 = with socket, with cable (10 m, 33 ft) ³⁾															
7 = with bayonet socket, with cable (10 m, 33 ft), only for V DC application ⁴⁾															
Control printed circuit board (P.C.B.)															
0 = none, only terminal board without time control, only for V DC application															
4 = control P.C.B. S4: NC contact or NO contact, programmable: 1-5 cycles, only for V DC application															
4 = control P.C.B. S4: NC contact or NO contact, programmable: 1 cycle with SSV 12, SSV 18; 1 to 3 cycles with SSV 6, SSV 8, only for V AC application															

¹⁾ For external metering devices application only use the specific metering devices SSV..KNQLS
²⁾ Do not use QLS 301 with SSV metering device in bottom-mounting position for mobile applications. Do not install the pump in areas exposed to shock.
³⁾ Connection types 1, 5, 6 can be combined with square plug version (1) only
⁴⁾ Connection types 7, 8 can be combined with bayonet plug version (5) only

Pump element and outlet accessories	
Order number	Description
650-28856-1	pump element K6
226-14091-4	outlet push-in fitting with clamping ring;
	check valve for hose with stud for Ø 6 mm tube
504-30344-4	outlet check valve assembly for Ø 6 mm tube
303-17499-3	outlet closure plug with sealing edge

Accessories	
Order number	Description
664-36078-7	cable kit, square plug black, cable (10 m, 33 ft); 4-core
664-36078-9	cable kit, square plug black, cable (10 m, 33 ft); 4-core
664-34045-1	cable kit, bayonet plug, cable (10 m, 33 ft) 4-core

Pump unit

QLS 301 SSV



Description

The Quicklub QLS 301 is a compact lubrication system designed to supply grease. The system package includes all necessary monitoring and control functions, as well as low-level control and a pressure-relief valve. Outlet connections and standard-pressure plastic tubing must be ordered separately. Up to 18 lubrication points can be supplied and monitored directly from the pump, and its reservoir features a follower plate, enabling rotating applications. The unit's integrated, all-in-one system concept reduces installation time and costs.

Features and benefits

- Back- or bottom-mounted progressive metering devices
- Internal lubricant return possible
- Integrated pressure-relief valve
- External programming via keypad
- System monitoring with display of faults
- Follower plate

Applications

- Machine tools
- Material handling
- Automotive industry
- Food processing
- Printing industry
- Renewable energies
- Farm machinery
- Construction

Technical data

Function principle	electrically operated piston pump with follower plate
Operating temperature	-25 to +70 °C; -13 to +158 °F
Operating pressure	205 bar; 2 975 psi
Lubricant	
grease:	NLGI 2
fluid grease:	NLGI 00, 000
Outlets	up to 18
Metering quantity ¹⁾	1,0 cm ³ /min; 0.06 in ³ /min
Reservoir	1 l; 0.26 gal
Connection main line via SSV:	see information for SSV
via connection block:	G 1/8
Operating voltage	12/24 V DC; 120 and 230 V AC (± 10%)
Protection class	IP 6K9K, NEMA 4
Dimensions	min. 237 × 215 × 230 mm min. 9.33 × 8.46 × 9.05 in max. 237 × 235 × 270 mm max. 9.33 × 9.25 × 10.63 in
Mounting position	any

¹⁾ Before metering devices



NOTE

Further technical information, technical drawings, accessories, spare parts or product function descriptions are available on SKF.com/lubrication:

951-171-003 EN

Pump unit and accessories

QLS 301 SSV

Identification code	P301 1
Product design	
Metering devices SSV	
<ul style="list-style-type: none"> 0 = external SSV 6-KNQLS, SSV 8-KNQLS 1 = external SSV 12-KNQLS, SSV 18-KNQLS 3 = SSV 6, rear-mounted 4 = SSV 8, rear-mounted 6 = SSV 12, rear- or bottom-mounted 9 = SSV 18, rear- or bottom-mounted 	
Assignment of metering device outlets	
<ul style="list-style-type: none"> 0 = no metering device 1 = vertical metering device outlets, V, rear mounted 2 = horizontal metering device outlets, H, bottom-mounted ¹⁾ 	
Operating voltage	
<ul style="list-style-type: none"> 2 = 12 V DC, available with or without control P.C.B. 4 = 24 V DC, available with or without control P.C.B. 6 = 120 V AC, only with control P.C.B. 8 = 230 V AC, only with control P.C.B. 	
Reservoir	
<ul style="list-style-type: none"> 1 = 1XL, 1 l; 0.26 gal, with low-level indication 	
Connection	
<ul style="list-style-type: none"> 0 = 1 connection left side: power supply (V DC/VAC) 1A, square plug. For industrial applications 2 = 1 connection left side: power supply (V DC) 1A, low-level or fault indication, bayonet plug. For vehicles only 1 = 2 connections: 1 × left side for power supply (V DC/VAC) 2A; 1 × right side for external low-level or fault indication, square plug. For industrial applications 	
Connection socket design	
<ul style="list-style-type: none"> 1 = square plug design A. For industrial applications ²⁾ 5 = bayonet plug 4-pole design. For vehicles ³⁾ 	
Electrical connector types	
<ul style="list-style-type: none"> 1 = with connection socket, without cable ²⁾ 5 = with connection socket and cable (10 m; 33 ft) ²⁾ 6 = with connection socket and ADR cable (10 m; 33 ft) ²⁾ 7 = with connection socket, bayonet and cable (10 m; 33 ft) ³⁾ 8 = with connection socket, bayonet and ADR cable (10 m; 33 ft) ³⁾ 	
Control printed circuit board (P.C.B.)	
<ul style="list-style-type: none"> 0 = without 4 = control P.C.B. S4; NC and NO contacts programmable 1-5 cycles; only for V DC application 4 = control P.C.B. S4; NC and NO contacts programmable; 1-3; only for V AC application 	

¹⁾ Not for use in areas with impact loads or vehicles
²⁾ Connection types 1, 5, 6 can be combined with square plug version (1) only
³⁾ Connection types 7, 8 can be combined with bayonet plug version (5) only

Pump element and outlet accessories	
Order number	Description
650-28856-1	pump element K6
226-14091-4	outlet push-in fitting with clamping ring;
	check valve for hose with stud for Ø 6 mm tube
504-30344-4	outlet check valve assembly for Ø 6 mm tube
303-17499-3	outlet closure plug with sealing edge

Accessories	
Order number	Description
664-36078-7	cable kit, square plug black, cable (10 m, 33 ft); 4-core
664-36078-9	cable kit, square plug black, cable (10 m, 33 ft); 4-core
664-34045-1	cable kit, bayonet plug, cable (10 m, 33 ft) 4-core

Pump unit

QLS 401 SSV



Description

The Quicklub QLS 401 SSV is a complete lubrication system that includes all necessary monitoring and control functions, as well as a pressure-relief valve and an enhanced reservoir-stirring paddle that prevents grease separation. Outlet connections and standard-pressure plastic tubing must be ordered separately. Up to 18 lubrication points can be supplied via an SSV metering device with fixed output amount and can be monitored directly from the pump. The unit's integrated, all-in-one system concept reduces installation time and costs.

Features and benefits

- Back- or bottom-mounted metering devices
- Internal lubricant return possible
- Integrated pressure-relief valve
- External programming via keypad
- System monitoring with display of faults

Applications

- Industrial and mobile applications
- Food processing
- Farm machinery
- Machine tools

Technical data

Function principle	electrically operated piston pump with stirring paddle
Operating temperature	-25 to +70 °C; -13 to +158 °F
Operating pressure	205 bar; 2 975 psi
Lubricant	grease: NLGI 2 fluid grease: NLGI 00, 000 up to 18
Outlets	up to 18
Metering quantity ¹⁾	1,0 cm ³ /min; 0.06 in ³ /min
Reservoir	1; 2 l; 0.26; 0.53 gal
Connection main line	see information for SSV via connection block: G 1/8
Operating voltage	12/24 V DC; 120 and 230 V AC (± 10%)
Protection class	IP 6K9K, NEMA 4
Dimensions	min. 237 × 215 × 230 mm max. 237 × 235 × 353 mm min. 9.33 × 8.46 × 9.05 in max. 9.33 × 9.25 × 13.89 in
Mounting position	upright

¹⁾ Before metering devices



NOTE

Further technical information, technical drawings, accessories, spare parts or product function descriptions are available on SKF.com/lubrication:

951-171-003 EN

Pump unit and accessories

QLS 401 SSV

Identification code	P401									
Product design										
Metering devices SSV...										
0 = external SSV 6-KNQLS, SSV 8-KNQLS	4 = SSV 8, rear-mounted									
1 = external SSV 12-KNQLS, SSV 18-KNQLS	6 = SSV 12, rear- or bottom-mounted									
3 = SSV 6, rear-mounted	9 = SSV 18, rear- or bottom-mounted									
Assignment of metering device outlets										
0 = no metering device										
1 = vertical metering device outlets, V, back mounted										
2 = horizontal metering device outlets, H, bottom mounted ¹⁾										
Operating voltage										
2 = 12 V DC, available with or without control P.C.B.										
4 = 24 V DC, available with or without control P.C.B.										
6 = 120 V AC, available with control P.C.B. only										
8 = 230 V AC, available with control P.C.B. only										
Reservoir										
0 = 1XN, 1 l; 0.26 gal, without low-level indication	2 = 2XN, 2 l; 0.53 gal, without low-level indication									
1 = 1XL, 1 l; 0.26 gal, with low-level indication	3 = 2XL 2 l; 0.53 gal, with low-level indication									
Connections										
0 = 1 connection left side, power supply (V DC/V AC) 1A, square plug. For industrial applications										
2 = 1 connection left side, power supply (V DC) 1A, low-level or fault indication, bayonet plug. For vehicles only										
1 = 2 connections: 1 × left side for power supply (V DC/V AC) 2A										
1 × right side for external low-level or fault indication, square plug. For industrial applications										
Connection socket design										
1 = square plug design A. For industrial applications ²⁾										
5 = bayonet plug 4-pole design. For vehicles ³⁾										
Electrical connector types										
1 = with connection socket, without cable ¹⁾	7 = with connection socket, bayonet and cable (10 m; 33 ft) ²⁾									
5 = with connection socket and cable (10 m; 33 ft) ¹⁾	8 = with connection socket, bayonet and ADR cable (10 m; 33 ft) ²⁾									
6 = with connection socket and ADR cable (10 m; 33 ft) ¹⁾										
Control printed circuit board (P.C.B.)										
0 = without										
4 = control P.C.B. S4 for 12/ 24 V DC; NC and NO contacts programmable 1-5 cycles										
4 = control P.C.B. S4 for 120/ 230 V AC; NC and NO contacts programmable; 1-3 cycles (SSV 6/ SSV 8), 1 cycle (SSV 12/ SSV 18)										
5 = control P.C.B. S4 for 12/ 24 V DC; NO contact signal ⁴⁾										
5 = control P.C.B. S5 for 120/ 230 V AC; NO contact signal; 1-3 cycles, (SSV 6/ SSV 8), 1 cycle (SSV 12/ SSV 18) ⁴⁾										
6 = control P.C.B. S6 for 12/ 24 V DC; NC contact signal ⁴⁾										
6 = control P.C.B. S6 for 12/ 24 V DC; NC contact signal: 1-3 cycles (SSV 6/ SSV 8) 1 cycle (SSV 12/ SSV 18) ⁴⁾										

¹⁾ Not for use in areas with impact loads or vehicles

²⁾ Connection types 1, 5, 6 can be combined with square plug version (1) only

³⁾ Connection types 7, 8 can be combined with bayonet plug version (5) only

⁴⁾ Control P.C.B. can be combined with XN reservoir versions only

Pump element and outlet accessories

Order number	Description
650-28856-1	pump element K6
226-14091-4	outlet push-in fitting with clamping ring; check valve for hose with stud for Ø 6 mm
504-30344-4	outlet check valve assembly
303-17499-3	outlet closure plug with sealing edge

Accessories

Order number	Description
664-36078-7	cable kit, square plug, cable (10 m, 33 ft); 4-core
664-36078-9	cable kit, square plug, cable (10 m, 33 ft); 4-core
664-34045-1	cable kit, bayonet plug, cable (10 m, 33 ft) 4-core

Pump unit

QLS 401 SSV DV



Description

The Quicklub QLS 401 SSV DV is a complete lubrication system that includes all necessary monitoring and control functions, as well as a pressure-relief valve and an enhanced reservoir-stirring paddle that prevents grease separation. Outlet connections and standard-pressure plastic tubing must be ordered separately. Up to 16 lubrication points can be supplied via an SSV DV metering device with adjustable output amount (using metering screws) and can be monitored directly from the pump. The unit's integrated, all-in-one system concept reduces installation time and costs.

Features and benefits

- Back- or bottom-mounted metering devices
- Internal lubricant return possible
- Integrated pressure-relief valve
- External programming via keypad
- System monitoring with display of faults

Applications

- Industrial and mobile applications
- Food processing
- Farm machinery
- Machine tools

Technical data

Function principle	electrically operated piston pump with stirring paddle
Operating temperature	-25 to +70 °C; -13 to +158 °F
Operating pressure	205 bar; 2 975 psi
Lubricant	grease: NLGI 2 fluid grease: NLGI 00, 000
Outlets	max. 16
Metering quantity	depending on metering screw; per outlet: 0,08-0,4 cm ³ /min; 0,0048-0,0244 in ³ /min
Reservoir	1; 2 l; 0.26; 0.53 gal
Connection main line	see information for SSV DV via connection block: G 1/8
Operating voltage	12/24 V DC (± 10%)
Protection class	IP 6K9K, NEMA 4
Dimensions	min. 237 × 215 × 230 mm max. 237 × 235 × 353 mm min. 9.33 × 8.46 × 9.05 in max. 9.33 × 9.25 × 13.89 in
Mounting position	upright



NOTE

Further technical information, technical drawings, accessories, spare parts or product function descriptions are available on SKF.com/lubrication:

951-171-003 EN, 12667 EN

Pump unit and accessories

QLS 401 SSV DV

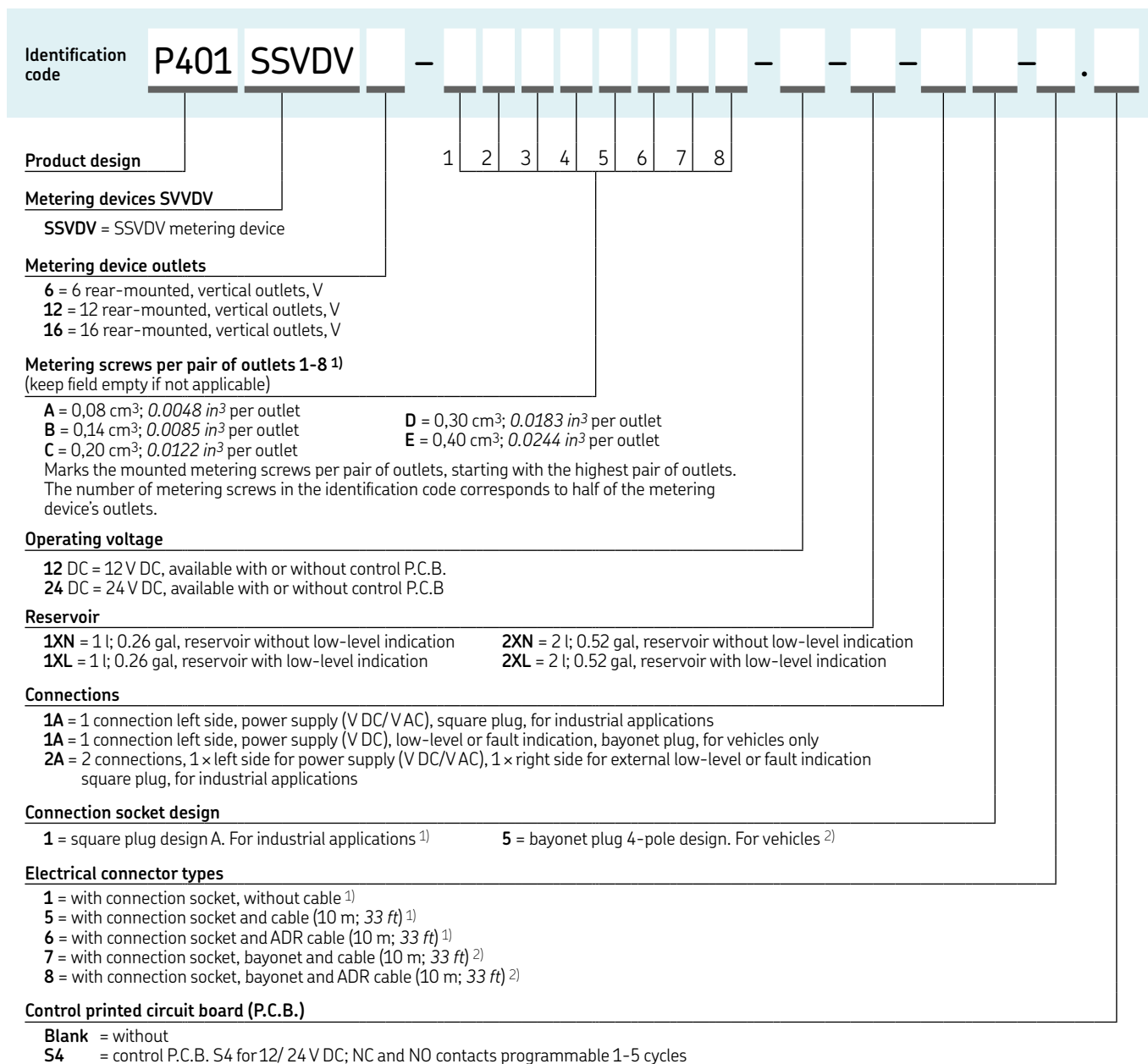

¹⁾ Connection types 1, 5, 6 can be combined with square plug version (1) only
²⁾ Connection types 7, 8 can be combined with bayonet plug version (5) only

Pump element and outlet accessories	
Order number	Description
650-28856-1	pump element K6
226-14091-4	outlet push-in fitting with clamping ring; check valve for hose with stud for Ø 6 mm tube
504-30344-4	outlet check valve assembly for Ø 6 mm tube
303-17499-3	outlet closure plug with sealing edge

Accessories	
Order number	Description
664-36078-7	cable kit, square plug, cable (10 m, 33 ft); 4-core
664-36078-9	cable kit, square plug, cable (10 m, 33 ft); 4-core
664-34045-1	cable kit, bayonet plug, cable (10 m, 33 ft) 4-core
549-34254-1	metering screw, 12 pieces; 0,08 cm ³ ; 0.005 in ³
549-34254-2	metering screw, 12 pieces; 0,14 cm ³ ; 0.009 in ³
549-34254-3	metering screw, 12 pieces; 0,20 cm ³ ; 0.012 in ³
549-34254-4	metering screw, 12 pieces; 0,30 cm ³ ; 0.018 in ³
549-34254-5	metering screw, 12 pieces; 0,40 cm ³ ; 0.024 in ³

Pump unit

QLS 421 SSV



Description

Designed for lubricating truck trailers and semi-trailers, the Quicklub QLS 421 is a complete lubrication system with an integrated metering device and controller, as well as a pressure-relief valve. The pump features a back-mounted SSV metering device and supplies grease only. Outlet connections and standard-pressure plastic tubing must be ordered separately. Up to 18 lubrication points can be supplied directly from the pump.

Features and benefits

- Compact progressive system
- Designed to supply grease
- Uses brake light as power supply via capacitor
- Lubricates at each braking until reaching set lubrication time

Applications

- Vehicles
- Trailers, semi-trailers
- Farm machinery
- Construction



Technical data

Function principle	electrically operated piston pump
Operating temperature	-25 to +70 °C; -13 to +158 °F
Operating pressure	205 bar; 2 975 psi
Lubricant	grease: NLGI 2 fluid grease: NLGI 00, 000
Outlets	up to 18
Reservoir	1; 2 l; 0.26; 0.53 gal
Metering quantity	1,0 cm ³ /min; 0.06 in ³ /min
Connection main line	see information for SSV via connection block: G 1/8
Operating voltage	12/24 V DC
Protection class	IP 6K9K, NEMA 4
Dimensions	min. 237 × 215 × 230 mm max. 237 × 235 × 353 mm min. 9.33 × 8.46 × 9.05 in max. 9.33 × 9.25 × 13.89 in
Mounting position	upright

 NOTE

Further technical information, technical drawings, accessories, spare parts or product function descriptions are available on SKF.com/lubrication.

Pump unit and accessories

QLS 421 SSV

Identification code	P421		1			2	5		1
Product design									
Metering devices SVV									
3 = SSV 6									
6 = SSV 12									
9 = SSV 18									
Metering device position									
1 = rear-mounted									
Operating voltage									
2 = 12 V DC									
4 = 24 V DC									
Reservoir									
0 = 1 l; 0.26 gal; without low-level control									
2 = 2 l; 0.53 gal; without low-level control									
Connections									
2 = 1A5 - 1 connection, power supply, bayonet plug, left									
Connection socket design									
5 = bayonet plug according to DIN 72858-1									
Electrical connector types									
3 = with connection socket and cable (10 m; 33 ft)									
4 = with connection socket and ADR cable (10 m; 33 ft)									
Control printed circuit board (P.C.B.)									
1 = with variable pause and lubrication time									

Accessories

Pump element and outlet accessories		Accessories	
Order number	Description	Order number	Description
650-28856-1	pump element K6	664-36078-7	cable kit, square plug, cable (10 m, 33 ft); 4-core
226-14091-4	outlet push-in fitting with clamping ring;	664-36078-9	cable kit, square plug, cable (10 m, 33 ft); 4-core
	check valve for hose with stud for Ø 6 mm tube	664-34045-1	cable kit, bayonet plug, cable (10 m, 33 ft) 4-core
504-30344-4	outlet check valve assembly for Ø 6 mm tube		
303-17499-3	outlet closure plug with sealing edge		

Pump unit

P 502



Description

The P 502 is a simple, economical, electrically operated lubrication pump unit. It can provide directly a maximum of two individual lubrication points with lubricant or be connected to progressive metering devices. An integrated control board is available to set pause and lubrication time. Developed for fluid grease and grease, the P 502 features an optimized housing shape and reservoir suitable for food processing applications.

Features and benefits

- Economical operation
- Fits in tight/small places
- Flexible design for 12 and 24 V DC voltage supply
- Optional pressure-release valve
- Optimised housing design for splash zones in food processing

Applications

- Commercial vehicles
- Farm machinery
- Small construction machines
- Food and beverage industry

Technical data

Function principle	electrically operated piston pump
Operating temperature	-25 to +70 °C; -13 to +158 °F
Operating pressure	270 bar; 3 915 psi
Lubricant	grease: up to NLGI 2
Outlets	1-2
Metering quantity	depending on pump element per outlet: 1,0-2,4 cm ³ /min; 0.06-0.15 in ³ /min
Reservoir	1 l; 0.26 gal
Connection main line	G 1/4
Operating voltage	12/24 V DC
Protection class	IP 6K9K; IP65; IP67 depending on type of electrical connection
Dimensions	250 × 150 × 270 mm 9.84 × 5.91 × 10.63 in
Mounting position with follower plate	any
without follower plate	upright



NOTE

Further technical information, technical drawings, accessories, spare parts or product function descriptions are available on SKF.com/lubrication:

12737 EN

Pump unit

P 502

Identification code

P502 - - - - - . - -

Product design

Reservoir plastic

- 1XN** = 1 l; 0.26 gal reservoir for grease
- 1XLF** = 1 l; 0.26 gal reservoir for grease, with follower plate and low-level signal

Pump elements 1-2 (choose max. 2 pump elements)

- .** = without pump elements
- 1K5** = 1,0 cm³/min; 0.06 in³/min; piston Ø 5 mm
- 1K6** = 1,2 cm³/min; 0.07 in³/min; piston Ø 6 mm
- 1K7** = 1,8 cm³/min; 0.11 in³/min; piston Ø 7 mm
- 1B7** = 2,4 cm³/min; 0.15 in³/min; piston Ø 7 mm

Operating voltage

- 2** = 12 V DC
- 4** = 24 V DC

Connections

- 1A** = 1 connection left-side supply voltage
- 2A** = 2 connections:
 - 1 connection left-side, supply voltage
 - 1 connection right-side, low-level signal, illuminated pushbutton

Type of connection

- 1** = square plug
- 2** = M 12 plug
- 5** = bayonet plug 4-pole, DIN 72585
- 6** = bayonet plug 7/5-pole, DIN 72585
- 7** = bayonet plug 7/6-pole, DIN 72585

Connections from the pump to external devices

- 00** = connection plug with closure cap, square plug M 12
- 01** = connection plug and socket, square plug M 12
- 10** = connection plug and socket, square plug, cable (10 m; 33 ft)
- 14** = bayonet socket, 4-core, with cable (10 m; 33 ft)
- 15** = bayonet socket, 7/5-core, with cable (10 m; 33 ft)
- 16** = bayonet socket, 7/6-core, with cable (10 m; 33 ft)

Control printed circuit board (P.C.B.)

- 00** = without control printed circuit board
- V10-V13** = control printed circuit board, supply voltage terminals 15 + 31
- V20-V23** = control printed circuit board, supply voltage terminals 15 + 30 + 31

Pump unit

P 502

Pump elements

Pumps 502 can be equipped with a maximum number of 2 pump elements. The gasket is always included. Please observe the assembly instructions 951-171-009-EN when installing additional pump elements. It is also possible to remove pump elements. The remaining hole must be plugged by a closure plug.

Each pump element must be secured by a pressure relief valve. Nickel-plated pump elements are used in corrosive conditions such as food and beverage industry. Pump element B7 DN is suited for problematic greases which are tougher than standard greases.

600-26877-2



Pump elements ¹⁾

Order number	Description	Material	Piston	Nominal output ⁶⁾	
			Ø mm	cm ³ /min	in ³ /min
600-78018-1	pump element L5 ²⁾	steel, gasnitro-carburized	5	0,2	0.01
600-26875-2	pump element K5	steel, gasnitro-carburized	5	0,8	0.05
600-26876-2	pump element K6	steel, gasnitro-carburized	6	1,3	0.08
600-26877-2	pump element K7	steel, gasnitro-carburized	7	1,8	0.11
655-28716-1	pump element KR	steel, gasnitro-carburized	7	0,3-1,5	0.02-0.09
600-28750-1 ³⁾	pump element C7	steel, gasnitro-carburized	7	1,8	0.11
600-29303-1	pump element K5 DN	steel, nickel-plated ⁵⁾	5	0,8	0.05
600-29304-1	pump element K6 DN	steel, nickel-plated ⁵⁾	6	1,3	0.08
600-29305-1	pump element K7 DN	steel, nickel-plated ⁵⁾	7	1,8	0.11
600-29185-1 ⁴⁾	pump element B7 DN	steel, nickel-plated ⁵⁾	7	0,8	0.05

¹⁾ male thread M 22 x 1,5; female thread G 1/4

²⁾ L only permitted for application of NLGI 00 lubrication grease

³⁾ pump element for supplying of chisel paste

⁴⁾ with bypass check valve

⁵⁾ for application in beverage industry

⁶⁾ The stated nominal outputs per minute and pump element refer to NLGI 2 lubrication greases at an ambient temperature of + 20 °C [68 °F] and a pressure of 100 bar [1450 psi] at the outlet of the pump element. Deviating operating conditions or deviating pump configuration result in a changed motor speed of 9 rpm and thus in a change of the output per time unit.

Return-line connector

The return-line connector is designed to feed grease quantities which are not required back into the pump reservoir (from a progressive metering device). It is installed in the mounting hole instead of a pump element.

Return-line connector with filler fitting, screw type

Order number	Description	Filling nipple	Thread	Tube
				Ø mm
504-30698-1	return-line connector	straight	R 1/4	6
504-36071-5	return-line connector	straight, with adapter	R 1/4	6
504-36071-6	return-line connector-line	90°	R 1/4	6
304-16543-1	adapter; for a return line connection instead of a closure plug (pump element)		M22x1,5xG1/4	

504-36071-5



Pump unit

P 502

Pressure relief valves

Order number	Designation	Description	Relief pressure		Connection type pressure line
			bar	psi	
624-28892-1	SVTE-270-1/4-D6	pressure relief valves	270	3 915	screw type fitting D6
624-28893-1	SVTE-270-1/4-D8	pressure relief valves	270	3 915	screw type fitting D8
624-29087-1	SVS-200-6-1/4-6	pressure relief valve assembly with grease return to the reservoir	200	2 900	push-in type D6
524-32231-1	retrofit kit	retrofit kit for existing pressure relief valve	–	–	–
235-14343-2	valve insert	for pressure relief valves as replacement	270	3 915	–
235-14343-1	valve insert	for pressure relief valves as replacement	200	2 900	–
235-14343-5	valve insert	for pressure relief valves as replacement	120	1 740	–
235-14343-4	valve insert	for pressure relief valves as replacement	80	1 160	–

Quick filling connector without filter, connection thread G¹/₄

Order number	Description	Connection
544-36961-1	filler fitting with protective cap	G ¹ / ₄
504-32125-1	coupling plug with protective cap	G ¹ / ₄
233-10765-3	protective cap; for replacement	G ¹ / ₄

Quick filling connector

Quick filling connectors can be installed either by removing the standard hydraulic nipple or by removing the closure plug instead of a pump element.

They are used for a quick filling with an hand-operated or pneumatic operated barrel pump. Please refer to the accessories catalogue regarding filling pumps

Quick filling connector

Order number	Description	Connection
540-36753-5	filler fitting assembly	M22x1,5
540-31800-1	filler fitting with filter	M22x1,5
504-36071-7	filler fitting without filter	M22x1,5

544-36961-1



Push button and fuse holder

Order number	Description	Description
664-85388-9	pushbutton red	12/24 VDC
237-13321-8	fuse holder	with fuse current load: 5 A

237-13321-8



Pump unit

P 603 M



Description

The compact P 603 M automatic lubrication pump consists of a housing with integrated motor, reservoir with stirring paddle, pump element with pressure-relief valve, filling nipple and electrical connection parts. It can drive up to three pump elements and operates according to a customer-supplied, external control unit (pause and lubrication times).

Versatile and economical, this pump can be enhanced with low-level control that enables control of lubrication cycles. The P 603 M can supply up to 100 lubrication points, depending on line length.

Features and benefits

- Reservoir size up to 100 l (26.4 gal) available
- Powerful and robust pump
- Drives up to three pump elements
- C5M corrosion protection available
- Pump elements could be internally combined to one outlet
- cUL certified

Applications

- Wind energy systems
- Construction
- Renewable energies



Technical data

Function principle	electrically operated piston pump
Operating temperature	-40 to +70 °C; -40 to +158 °F
Operating pressure	350 bar; 5 075 psi
Lubricant	grease: up to NLGI 2
Outlets	up to 3 pump elements
Metering quantity	depending on pump element; 4 cm ³ /min; 0.24 in ³ /min
Lubricant output ¹⁾	max. 12 cm ³ /min; 0.73 in ³ /min
Reservoir	4, 8, 10, 15, 20, 30 ²⁾ and 100 ²⁾ l; 1.05, 2.11, 2.64, 3.96, 5.28, 7.92 ²⁾ gal and 26.4 ²⁾ gal
Connection main line	G 1/4
Operating voltage	24 V DC, 100-240 V AC, 50/60 Hz
Protection class	IP 6K9K
Certification	cUL, CE
Dimensions	min. 240 × 235 × 415 mm max. 500 × 500 × 1064 mm min. 9.45 × 9.25 × 16.34 in max. 19.96 × 19.96 × 41.89 in
Mounting position with stirring paddle	reservoir upside
with follower plate	any

- ¹⁾ with internally combined three pump elements to one outlet
²⁾ design only available without follower plate



NOTE

Further technical information, technical drawings, accessories, spare parts or product function descriptions are available on SKF.com/lubrication:

12735 EN

Pump unit

P 623 M



Description

P 623 M electrically operated pumps have been designed to withstand electromagnetic pulses caused by lightning strikes. An extension of the P603 pump series, the P623 M is for use in progressive automatic lubrication systems. Working closely with customers to develop product solutions that meet specific needs, SKF developed the P623 M for onshore and offshore wind energy applications. In addition, these pump units are suitable for use in construction, mining and renewable energy applications where lightning protection must be considered. P623 M pumps feature a power supply board that transfers 230 V to 24 V (control) with overvoltage protection to discharge 8 kV (electric grounding). The pump units are available with a grease follower plate for rotating applications or a stirring paddle for stationary applications.

Features and benefits

- Reduces operational risk compared to standard automatic lubrication
- Offers higher safety standards
- Brings lubrication system into compliance

Applications

- Wind energy generators
- Construction, mining
- Renewable energies



Technical data

Function principle	electrically operated piston pump with lightning protection
Operating temperature	-25 to +55 °C; -13 to +131 °F
Operating pressure	300 bar; 4 351 psi
Lubricant	grease: up to NLGI 2
Outlets	up to 3 pump elements
Metering quantity	depending on pump element; 4 cm ³ /min; 0.24 in ³ /min
Lubricant output ¹⁾	max. 12 cm ³ /min; 0.73 in ³ /min
Reservoir	4, 8, 10, 15 and 20 l; 1.05, 2.11, 2.64, 3.96 and 5.28 gal
Connection main line	G ³ / ₄
Operating voltage	100-240 V AC, 50/60 Hz
Protection class	IP 67
LPZO (Lightning Protection Zone)	8 kV (acc. EN61000-6-2)
EMC (Electromagnetic compatibility)	2014/30/EU
Dimensions	min. 220 × 278 × 439 mm max. 220 × 278 × 976 mm min. 8.66 × 10.94 × 17.28 in max. 8.66 × 10.94 × 38.42 in
Mounting positions: with stirring paddle	reservoir upside
with follower plate	any

¹⁾ with internally combined three pump elements to one outlet



NOTE

Further technical information, technical drawings, accessories, spare parts or product function descriptions are available on SKF.com/lubrication:

16797 EN

Pump unit

P 623 M

Identification code: **P623M** - - - - **AC** -

Product design

Corrosion class
 _ = C3
 X = C5-M

Reservoir capacities
 4 = 4 l; 1.05 gal 15 = 15 l; 3.96 gal
 8 = 8 l; 2.11 gal 20 = 20 l; 5.28 gal
 10 = 10 l; 2.64 gal

Reservoir construction
 XN = grease reservoir without low-level indication
 XL = grease reservoir with low-level indication
 XNBO = grease reservoir without low-level indication and refilling from top
 XLBO = grease reservoir, with low-level indication and refilling from top
 XLF = grease reservoir with empty message and follower plate

Pump elements
 ... = without pump elements
 1K7 = 4,0 cm³/min; 0.24 in³/min (single pump element)
 2K7 = 2 × 4,0 cm³/min; 2 × 0.24 in³/min (2 outlets)
 3K7 = 3 × 4,0 cm³/min; 3 × 0.24 in³/min (3 outlets)
 2Z7 = 8 cm³/min; 0.48 in³/min (2 pump elements combined in one outlet)
 3Z7 = 12 cm³/min; 0.73 in³/min (3 pump elements combined in one outlet)

Power supply
 AC = 120–240 V AC ± 10%; 50–60 Hz ± 5%; Motor 24 V DC

Electric connections
 00 = no signal connection H2 (X4) = Harting connector, 7 Pin
 H1 (X2) = Harting connector, 5 Pin H3 (X4) = Harting connector, 7 Pin



Pump element

Order number	Description	Metering quantity	
		cm ³ /stroke	in ³ /stroke
645-29873-1	C3 pump element K7 incl. sealing ring	0,246	0.015
645-77196-1	C3 outlet combinable pump element Z7 incl. sealing ring	0,246	0.015
645-77734-1	C5-M pump element K7 incl. sealing ring	0,246	0.015
645-77625-1	C5-M outlet combinable pump element Z7 incl. sealing ring	0,246	0.015

Pressure relief valve

Order number	Designation	Opening pressure		
		bar	psi	Ø mm
624-29056-1	SVET-350-G 1/4A-D6	350	5 075	6
624-29054-1	SVET-350-G 1/4A-D8	350	5 075	8

Pump unit

P 653 M



Description

The compact P 653 M automatic lubrication pump consists of a housing with integrated motor, reservoir with stirring paddle, pump element with pressure-relief valve, filling nipple and electrical connection parts. It can drive up to three pump elements and operates according to a customer-supplied, external control unit (pause and lubrication times). Versatile and economical, this pump can be enhanced with low-level control that enables control of lubrication cycles. The P 653 M can supply up to 100 lubrication points, depending on line length.

Features and benefits

- Reservoir size up to 100 l (26.4 gal) available
- Powerful and robust pump
- Drives up to three pump elements
- C5M corrosion protection available
- Pump elements could be internally combined to one outlet
- cUL certified

Applications

- Wind energy systems
- Construction
- Renewable energies



Technical data

Function principle	electrically operated piston pump
Operating temperature	-40 to +70 °C; -40 to +158 °F
Operating pressure	350 bar; 5 075 psi
Lubricant	grease: up to NLGI 2
Outlets	up to 3 pump elements
Metering quantity	depending on pump element; 8 cm ³ /min; 0.48 in ³ /min
Lubricant output ¹⁾	max. 24 cm ³ /min; 1.44 in ³ /min
Reservoir	4, 8, 10, 15, 20, 30 ²⁾ and 100 ²⁾ l; 1.05, 2.11, 2.64, 3.96, 5.28, 7.92 ²⁾ gal and 26.4 ²⁾ gal
Connection main line	G 1/4
Operating voltage	90-264 V AC, 50/60 Hz; 24 V DC
Protection class	IP 6K 9K
Certification	cUL, CE
Dimensions	min. 240 × 235 × 467 mm max. 500 × 500 × 1064 mm min. 9.45 × 9.25 × 18.4 in max. 19.96 × 19.96 × 41.89 in
Mounting positions:	
with stirring paddle	reservoir upside
with follower plate	any

- ¹⁾ with internally combined three pump elements to one outlet
²⁾ design only available without follower plate



NOTE

Further technical information, technical drawings, accessories, spare parts or product function descriptions are available on SKF.com/lubrication:

16797 EN

Pump unit

P 653 M

Identification code P603M - - - - -

Product design

Corrosion-protection class
 _ = C3
 X̄ = C5-M

Certification
 _ = CE
 Ū = UL, cUL, CE

Reservoir size 2)
4 = plastic, transparent, 4 l; 1.05 gal **20** = plastic, transparent, 20 l; 5.28 gal
8 = plastic transparent, 8 l; 2.11 gal **30** = metal, 30 l; 7.92 gal
10 = plastic, transparent, 10 l; 2.64 gal **100** = metal, 100 l; 26.4 gal
15 = plastic, transparent, 15 l; 3.96 gal

Reservoir type
 XN = grease reservoir without low-level indication
 XL = grease reservoir with low-level indication 2)
 XNBO = grease reservoir without low-level indication and refilling from top
 XLBO = grease reservoir, with low-level indication and refilling from top
 XLF = grease reservoir with empty message and follower plate 1)

Pump elements
 ... = without pump elements **2Z7** = 16 cm³/min; 0.96 in³/min
1K7 = 8,0 cm³/min; 0.48 in³/min (single pump element) (2 pump elements combined in one outlet)
2K7 = 2 × 8,0 cm³/min; 0.48 in³/min (2 outlets) **3Z7** = 24 cm³/min; 1.44 in³/min
3K7 = 3 × 8,0 cm³/min; 0.48 in³/min (3 outlets) (3 pump elements combined in one outlet)

Operating voltage
24 = 24 V DC **AC** = 90-264 V AC; 50/60; Motor 24 V DC

Connections
1A = DC Bayonet plug, 7-pole for power supply DC and low-level control (XLBO)
1A = AC Square-type plug for power control (XLF) 1)
2A = AC Square-type plug for power supply, Bayonet plug 4-pole for low-level control (XLBO)

Type of connection
1 = square-type plug **7** = bayonet plug 7/7-pole 2)

Connections from the pump to external devices
00 = without connection socket and without cable
16 = bayonet socket with 10 m cable, 7-wire

1) With follower plate pumps, the empty signal can be picked up at the top of the cube plug (container lid). 30 and 100 l design only available without follower plate.
 2) Only with connection 1A7

Pump element		Metering quantity	
Order number	Description	cm ³ /stroke	in ³ /stroke
645-29873-1	C3 pump element K7 incl. sealing ring	0,246	0.015
645-77196-1	C3 outlet combinable pump element Z7 incl. sealing ring	0,246	0.015
645-77734-1	C5-M pump element K7 incl. sealing ring	0,246	0.015
645-77625-1	C5-M outlet combinable pump element Z7 incl. sealing ring	0,246	0.015

Pressure relief valve		Opening pressure			Connection
Order number	Designation	bar	psi	Ø mm	
624-29056-1	SVET-350-G 1/4A-D6	350	5 075	6	
624-29054-1	SVET-350-G 1/4A-D8	350	5 075	8	

Pump unit

ZPU 01/02



Description

The ZPU 01/02 high-pressure, high-volume pumps can be used as a supply pump for small to midsize dual-line systems or for progressive systems.

Depending on the system layout, these electric pumps can supply lubricant within a 50 m (54 yd) radius at a maximum pressure of 400 bar (5 800 psi). Available with 10 or 30 l (2.6 or 8 gal) reservoirs, these units are compatible with oil and grease up to NLGI 2 (NLGI 3 upon request). Featuring one or two elements, the ZPU 01/02 pumps work effectively in a broad temperature range thanks to the integrated stirring device.

Features and benefits

- Reliable
- Versatile
- Ultrasonic low- and high-level control options
- Free shaft end for use with other motors

Applications

- Light to medium industrial applications
- Mixing machines
- Power plants
- Reclaimers
- Stackers

Technical data

Function principle	electrically operated piston pump
Operating temperature	-20 to +70 °C; -4 to +158 °F
Operating pressure	
M100; M490	max. 350 bar; 5 075 psi
M049	max. 400 bar; 5 800 psi
Lubricant	grease: NLGI 2, NLGI 3 on request oil: viscosity 20–1 500 mm ² /s at operating temperature
Metering quantity ¹⁾	
ZPU01	13,33 cm ³ /min; 0.813 in ³ /min
ZPU02	26,67 cm ³ /min; 1.63 in ³ /min
ZPU02-M049	53,33 cm ³ /min; 3.25 in ³ /min
Reservoir	10 or 30 l; 2.6 or 8 gal
Connection main line	
Model V	for tube Ø 10mm
Model E	G 1/4
Operating voltage	380–420 V AC/50 Hz, 440–480 V AC/60 Hz; (± 10%)
Protection class	IP 65
Dimensions	min. 514 × 379 × 317 mm max. 754 × 431 × 337 mm min. 20.25 × 15.00 × 12.50 in max. 29.75 × 17.00 × 15.00 in
Low-level sensor	30 × 125 × 65 mm 1.20 × 5.00 × 2.75 in
Mounting position	upright

¹⁾ Output increase by 20% for 60 Hz applications



NOTE

Further technical information, technical drawings, accessories, spare parts or product function descriptions are available on SKF.com/lubrication:

951-171-016 EN



3D

skf-lubrication.partcommunity.com/3d-cad-models

Pump unit

ZPU 01/02

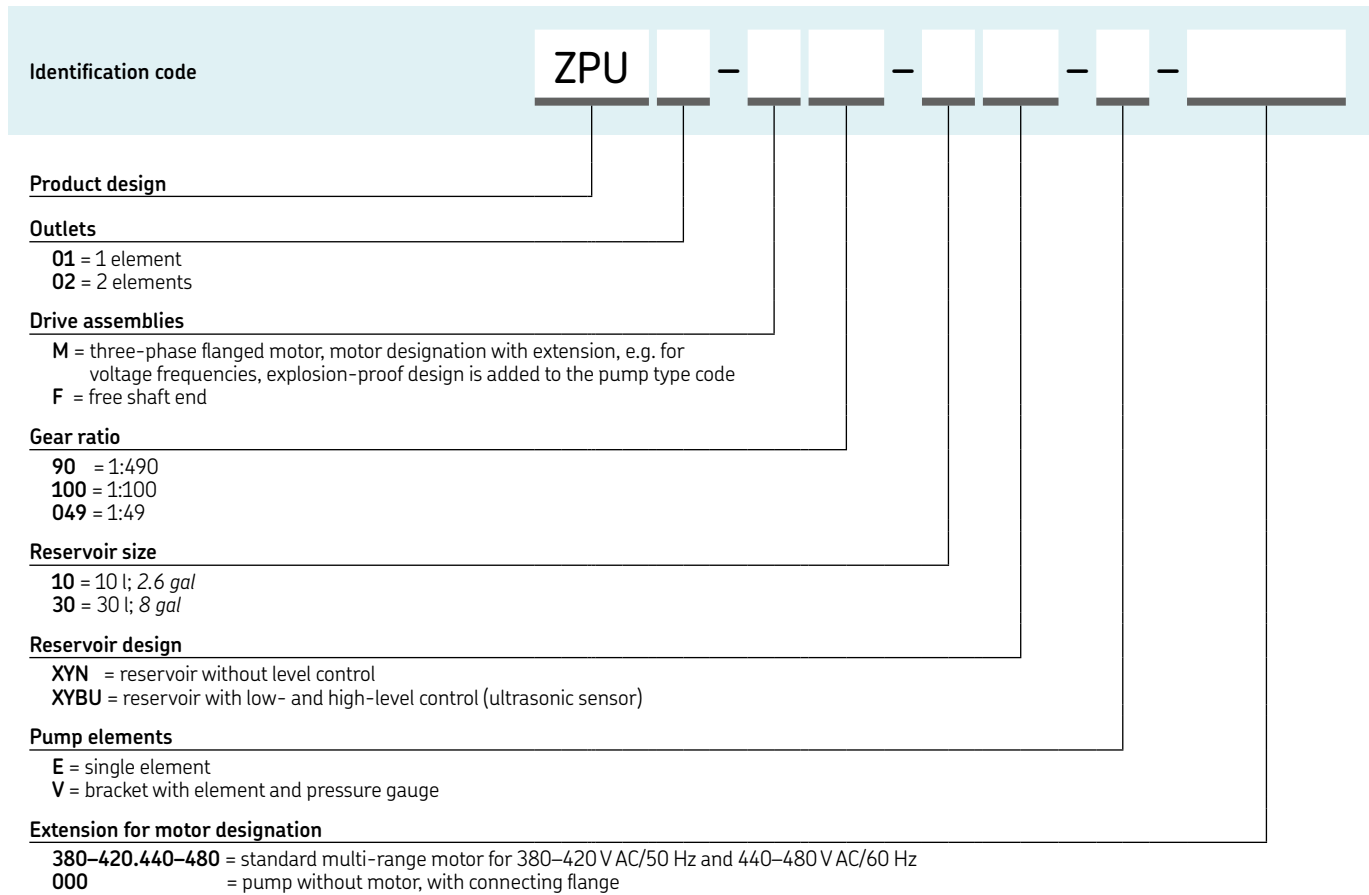

Pump unit

EDL1



Description

The EDL1 is an easy-to-use, electrical pressure booster for sectional lubrication systems. High output pressure enables provision of lubricant from a single source to progressive metering devices and distant lubrication points with different lubricant requirements. Low input pressure of 2 bar (29 *psi*), allows for retrofit installations in existing systems. For operation of EDL1 an additional feeder pump is required.

Features and benefits

- Cost-effective solution
- Environmentally friendly; no need for pressurized air; can be driven by solar panels
- Virtually maintenance free
- User-friendly design and operation
- Flexible inlet and outlet positions
- Sends fault messages remotely
- Optional pressure switch available

Applications

- Food and beverage
- Wayside lubrication in rail applications
- Cement industry
- Other heavy industries

Technical data

Function principle	electronically operated lubricator
Operating temperature	-25 to +70 °C; -13 to +158 °F
Operating pressure	max. 280 bar; 4 015 <i>psi</i>
Inlet pressure	min. 2 bar; max. 280 bar <i>min. 30 psi; max. 4 015 psi</i>
Lubricant	grease: NLGI 1 and 2
Outlets	1
Metering quantity	
full stroke	1 cm ³ /min; 0.06 in ³ /min
half stroke	0,5 cm ³ /min; 0.03 in ³ /min
Operating voltage	24 V DC (± 10%)
Connection main line	GE-LX10 (others on request)
Protection class	IP 65
Dimensions	116 × 114 × 350 mm 4.56 × 4.48 × 13.78 in
Mounting position	any

 NOTE

Further technical information, technical drawings, accessories, spare parts or product function descriptions are available on SKF.com/lubrication:
951-171-010 EN, 16144 EN

 CAD: skf-lubrication.partcommunity.com

Pump unit

EDL1

Identification code	EDL1 - [] [] [] - [] - [] + 924
Product design	
Material corrosion protection; inlet/outlet position	<ul style="list-style-type: none"> 1 = (standard) metal parts/piston based on C3 I/O: left/right 2 = metal parts/piston based on C3 I/O: right/right 3 = metal parts/piston based on C3 I/O: right/left 4 = metal parts/piston based on C3 I/O: left/left
Inlet connection ¹⁾	<ul style="list-style-type: none"> 0 = without connection 5 = GE-L Ø 10 mm
Outlet or outlet connection at check valve ¹⁾	<ul style="list-style-type: none"> 0 = without connection 5 = GE-L Ø 10 mm E = GE-L Ø 10 mm with cable and pressure switch 300 bar; 4 350 psi M = GE-L Ø 10 mm with cable pressure switch 100 bar; 1 450 psi
Controlling and timing	<ul style="list-style-type: none"> 01 = start-stop operation settings: volume = 1 cm³; 0.155 in³; full stroke 11 = automatic mode; machine contact; settings: volume = 1 cm³; 0.155 in³; full stroke 61 = pulse mode; settings: open
Electric connection	<ul style="list-style-type: none"> 00 = 3 × blind plug 01 = 2 × blind plug; with 1 × M 16 cable screw connection 11 = 1 × blind plug; with 2 × M 16 cable screw connection 31 = power supply; with 2 × M 16 cable screw connection
Power supply	<ul style="list-style-type: none"> 924 = 24 V DC

¹⁾ Composition defined by material: corrosion protection

Accessories

DSB1-S30000X-1A-01



Pressure switch

Order number	Description
DSB1-S30000X-1A-01	pressure switch; 300 bar; 4 840 psi
664-85046-3	connection cable for pressure switch

Pressure gauge

Order number	Description
169-140-001	pressure gauge (0-400 bar; 0- 5800 psi) damped version, with glycerin filling

Pump unit

E-PUMP



Description

The electrical barrel pumping unit E-PUMP is a versatile barrel pump and it is especially designed for pumping oil or grease lubricants up to NLGI grade 2 into a centralized lubrication system. When equipped with a change-over valve unit, as E-VALV e.g. or a shut-off valve as E-VALVE-S e.g. it can be used either in single-line, dual-line or progressive lubrication systems. A complete pumping center consists of a pumping unit and a lid set. EPUMP-XXX-ECO coding is referring to ECO lid sets (descending pump head with follower plate), which are suitable for greases in NLGI grades 1 and 2 while EPUMP-XXX-STA coding is referring to STA lid sets (pump head always at barrel bottom), which are suitable for oil or greases in NLGI 0, 00 and 000 classes.

Features and benefits

- E-Pump models reflecting typical and often used barrel sizes
- Compact electrically operated pump for applications where no air supply is available
- An internal pressure control and a heating element secure the pump's function in high-pressure conditions and cold climates

Applications

- Heavy industries (paper, steel and other process industries)
- Mining and mineral processing
- Machinery workshops
- Food and beverage
- Cement industry



Technical data

Function principle	electrically operated pump
Outlets	1
Number of pump elements	4
Metering quantity	55 g/min; 0.3880136 oz/min
Operating temperature	-30 to +70 °C, -20 to 160 °F
Operating pressure	max. 240 bar, 3 480 psi
Lubricant	grease up to NLGI 2 oil up to 40–1 000 mm ² /s
Supply voltage	20–32 V DC
Power consumption	150 W
Heater	40W/24V, heater resistor for pump elements in ECO models LED's 5 yellow, 1 green, 1 red
Display	18, 50 and 180 kg, 40, 120 or 400 lb
Drum capacity	drum not included
Pressure sensor	50–240 bar adjustable in 25 bar steps 725.1 to 3480.9 psi in 362.6 psi steps
Protection class	IP 65
Dimensions	depending on the model min. 400 × 400 × 800 mm max. 400 × 400 × 1 300 mm min. 15.75 × 15.75 × 31.49 in max. 15.75 × 15.75 × 51.18 in
Mounting position	vertical



NOTE

Further technical information, technical drawings, accessories, spare parts or product function descriptions are available on SKF.com/lubrication.

Pump unit

E-PUMP

Order information					
Order number	Designation	Lubricant	Control	Suitable barrel size	
				kg	gal
12375170	SKF-EPUMP-1/8-ECO-24-P	Grease up to NLGI 2	integrated control unit for progressive systems	18	4.5
12375090	SKF-EPUMP-1/4-ECO-24-P	Grease up to NLGI 2	integrated control unit for progressive systems	50	13
12375010	SKF-EPUMP-1/1-ECO-24-P	Grease up to NLGI 2	integrated control unit for progressive systems	180	45
12375210	SKF-EPUMP-1/8-STA-24-P	Oil up to 1 000 mm ² /s	integrated control unit for progressive systems	18	4.5
12375130	SKF-EPUMP-1/4-STA-24-P	Oil up to 1 000 mm ² /s	integrated control unit for progressive systems	50	13
12375050	SKF-EPUMP-1/1-STA-24-P	Oil up to 1 000 mm ² /s	integrated control unit for progressive systems	180	45

Accessories

Lid sets for grease barrels



Lid sets for grease barrels

Order number	Designation	Lubricant	for barrel size	
			kg	lb
12381280	E-LIDSET-1/8-ECO	Grease	18	40
12381285	E-LIDSET-1/4-ECO	Grease	50	120
12381290	E-LIDSET-1/1-ECO	Grease	180	400

Lid sets for oil

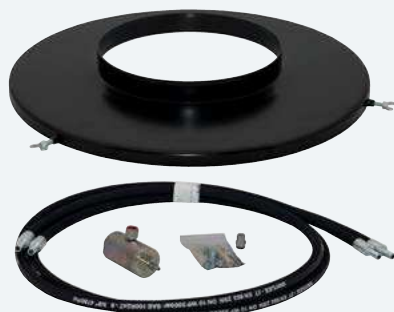

Lid sets for oil barrels

Order number	Designation	Lubricant	for barrel size	
			kg	lb
12381292	E-LIDSET-1/8-STA	Oil	18	40
12381294	E-LIDSET-1/4-STA	Oil	50	120
12381296	E-LIDSET-1/1-STA	Oil	180	400

Pump unit

PPU-5/PPU-35



Description

PPU-5 and PPU-35 are air-operated piston pumps designed to supply either oil or grease. They feature a spring-loaded piston that can be activated either by a 3/2-way or 4/2-way valve connection, which must be ordered separately. A reservoir (for grease only) can be connected to the pump via an intermediate plate or directly to the machine for a remote reservoir connection. Output can be modified via the adjusting screw.

Features and benefits

- Compact pump for either grease and oil within progressive system
- Adjustable output via stroke setting screw
- Direct connect reservoir or remote connect reservoir possible
- Optional low-level control available, only with integrated reservoir
- Hydraulically operated version of pump available, see under hydraulic pumps

Applications

- Small progressive systems
- Engine building
- Tube bending machines



Technical data

Function principle	air-operated piston pump
Operating pressure ¹⁾	160 bar; 2 320 psi
Air pressure	adjustable 4,5-10 bar; 65-145 psi
Priming pressure	30 bar; 435 psi
Lubricant	oil and grease: up to NLGI 2
Outlets	1
Metering quantity per stroke	
PPU-5	0,1-0,5 cm ³ ; 0.006-0.03 in ³
PPU-35	0,7-3,5 cm ³ ; 0.043-0.21 in ³
Reservoir	2,5 and 5 l; 0.66 and 1.32 gal
Connection main line	tube Ø 10 mm
Dimensions	min. 247 × 40 × 120 mm max. 270 × 83 × 126 mm min. 9.72 × 1.57 × 4.72 in max. 10.63 × 3.27 × 4.96 in
Mounting position	any

¹⁾ Rupture disc, other pressures available



NOTE

Further technical information, technical drawings, accessories, spare parts or product function descriptions are available on SKF.com/lubrication:

951-170-012 EN

Pump unit

PPU-5/PPU-35

Order number	Reservoir integrated		Low-level control integrated
	l	gal	
PPU-5	no	no	no
PPU-5-2.5	2,50	0.66	no
PPU-5-2.5W	2,50	0.66	yes
PPU-5-5	5	1.32	no
PPU-5-5W	5	1.32	yes

Order number	Reservoir integrated		Low-level control integrated
	l	gal	
PPU-35	no	no	no
PPU-35-2.5	2,50	0.66	no
PPU-35-2.5W	2,50	0.66	yes
PPU-35-5	5	1.32	no
PPU-35-5W	5	1.32	yes

Accessories

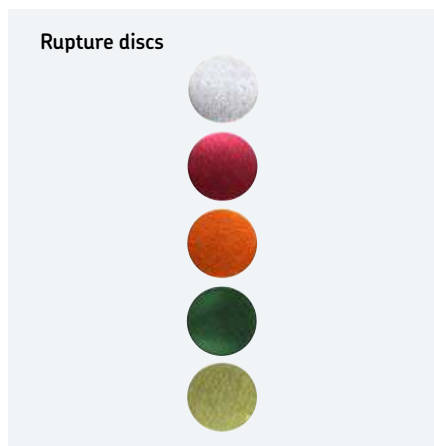

Order number	Colour	Burst pressure		Thickness	
		bar	psi	mm	in
PPU-BS60	black	60	870	0,152	0.006
PPU-BS80	green	80	1 160	0,203	0.008
PPU-BS100	yellow	100	1 450	0,254	0.010
PPU-BS120	red	120	1 740	0,305	0.012
PPU-BS140	orange	140	2 030	0,356	0.014
PPU-BS160	silver	160	2 320	0,406	0.016
PPU-BS180	pink	180	2 610	0.457	0.018

Pump

87214



Description

The model 87214 pump is an air-operated, single-acting pump requiring a timer and three-way valve to control the cycles. Air pressure powers the piston on the delivery stroke, and a spring returns it to priming position. Depending on the type of reservoir used, the pump is suitable for both grease and oil applications. The 87214 pump requires a specially designed reservoir that must be ordered separately.

Features and benefits

- Pump can be removed from reservoir without disturbing existing piping
- Inlet shut-off valve in reservoir base allows removal of pump without draining reservoir

Applications

- Heavy-duty machinery
- Printing industry
- Metal cutting
- Metal forming
- Wood working and processing

Technical data

Function principle	air-operated single acting pump ^{1) 2)}
Operating pressure	min. 4 bar, max. 14 bar <i>min. 60 psi, max. 200 psi</i>
Lubricant	oil and grease: NLGI 0-2
Outlets	1
Metering quantity ³⁾	
Oil	max. 30 strokes/min
Grease	<i>max. 22 strokes/min</i> 0,164-0,98 cm ³ /stroke <i>0.01-0.06 in³/stroke</i>
Reservoir	see accessories
Ratio	18:1
Connection main line	1/4 NPTF
Dimensions	162 × 44,5 × 44,5 mm <i>6.38 × 1.75 × 1.75 in</i>
Mounting position	upright

¹⁾ Needs to connect special reservoir to pump, see accessories

²⁾ Pump includes NBR O-rings

³⁾ Output adjustable by steps of one turn of adjustment screw equal to 0,049 cm³; 0.003 in³



NOTE

Further technical information, technical drawings, accessories, spare parts or product function descriptions are available on SKF.com/lubrication.

Pump

87214

Pump 87214

Order number	Description
87214	air-operated single acting pump, ratio 18:1, pump includes NBR O-rings

Accessories

Reservoir



Description

These reservoirs made of acryl are designed to be mounted directly onto the pump. They include all connections for air (or hydraulic oil, see hydraulically driven pump 87212, see p. 68) and lubricant outlet. They include a gauge 200 bar; 3 000 psi and an atmospheric indicator 62 bar; 900 psi.

Modular reservoirs

Order number	Lubricant	Capacity		Connection ¹⁾	Dimensions	
		l	gal		mm	in
87402	grease	1,475	0.389	1/8	295 × 172,2 × 179,6	11.6 × 6.78 × 7.06
87403	grease	2,450	0.647	1/8	371 × 172,2 × 179,6	14.6 × 6.78 × 7.06
87405	oil	2,365	0.624	1/8	262 × 172,2 × 179,6	10.3 × 6.78 × 7.06

¹⁾ For air supply and lubricant outlet

Pump

87200/87216/130179



Description

SKF's modular pumps are designed to efficiently supply either grease or oil in automatic systems using progressive metering devices. Models 87200, 87216 and 130179 are air-operated pumps that must be equipped with an appropriate baseplate and reservoir to make up a pump assembly. Baseplates contain all inlet and outlet connections for the pump and lubrication system and allow for quick pump removal without disturbing any existing piping. Removal of the pump does not require draining of the reservoir due to an integral check valve in the baseplate. Pump cycles will be controlled by a timer in conjunction with a three-way valve (supplied separately).

Features and benefits

- No dismantling of piping when removing pump
- No draining required due to integral check valve in baseplate
- Precise adjustability of output

Applications

- Small progressive systems
- Printing industry, material handling
- Metal processing



NOTE

Further technical information, technical drawings, accessories, spare parts or product function descriptions are available on SKF.com/lubrication.

Technical data

Function principle	air-operated single acting piston pump ¹⁾
Inlet pressure air	min. 2,8 bar, max. 10 bar
87200; 87216	min. 40 psi, max. 150 psi
130179	min. 4,5 bar, max. 10 bar
Lubricant	min. 65 psi, max. 150 psi
Outlets	oil and grease: NLGI 0-2
Metering quantity ²⁾	1
87200	0,041-0,164 cm ³ /stroke
	0,025-0,10 in ³ /stroke
87216	0,164-0,82 cm ³ /stroke
	0,01-0,05 in ³ /stroke
130179	4,1-16,39 cm ³ /stroke
	0,25-1,0 in ³ /stroke
Oil	
87200; 87216	max. 30 strokes/min
130179	max. 25 strokes/min
Grease	
87200; 87216	max. 22 strokes/min
130179	max. 10 strokes/min
Ratio, pressure	25:1
87200; 87216	50:1
130179	
Connection main line	1/4 NPTF
Dimensions	pumps only
87200; 87216	251 × 70 × 70 mm
	9,88 × 2,75 × 2,75 in
130179	114 × 291 × 140 mm
	4,50 × 15,38 × 5,50 in
Mounting position	with reservoir upside up

¹⁾ Needs for operation modular baseplate and reservoir, see accessories

²⁾ Output adjustable by steps of one turn of adjustment screw

Pump

87200/87216/130179

Order information				
Order number	Ratio	Baseplate		
		87218 ¹⁾	87204 ²⁾	130095 ³⁾
87200	25:1	•	•	–
87216	50:1	•	•	–
130179 ³⁾	25:1	–	–	•

- ¹⁾ For use with Modular Lube reservoirs
- ²⁾ For machine mount, use with remote reservoir customer's supply
- ³⁾ With valved piston uses Modular Lube reservoirs or pressurized (max. 140 bar; 2 000 psi) lubrication supply

Accessories



Baseplate

87218/87216/130179				
Order number	Air NPTF (F) inlet	Lubricant NPTF (F) inlet	outlet	
	<i>in</i>	<i>in</i>	<i>in</i>	
87218 ¹⁾	1/8	3/8	1/4	
87216 ²⁾	1/4	3/8	1/4	
130179 ³⁾	1/4	1/4	1/4	

- ¹⁾ All baseplates use atmospheric indicatoR100 bar; 1450 psi
- ²⁾ For use with Modular Lube reservoirs
- ³⁾ For machine mount, use with remote reservoir customer's supply

Description

Baseplates can be intermediate (for use with Modular Lube reservoirs) or machine mount (for use with remote reservoirs). They have all main connections for hydraulic oil and lubricant included. They include FKM O-rings.



Reservoir

Modular reservoirs for oil systems ¹⁾						
Order number	Description	Capacity		Lubricant outlet NPTF(F)	Dimensions	
		l	gal	<i>in</i>	mm	<i>in</i>
87400	cylindrical, acrylic	2,40	0.63	1/2	400 × 153 × 135	15.7 × 6.0 × 5.3
87413	cylindrical, acrylic	4,70	1.25	1/2	450 × 168 × 199	17.7 × 7.3 × 7.47
87417	tank, steel	18,90	5	3/8	258 × 445 × 319	10.1 × 17.5 × 12.6
87418	tank, steel	11,30	3	3/8	258 × 343 × 294	10.1 × 13.5 × 11.6
87419	tank, steel	5,70	1.50	3/8	258 × 267 × 192	10.1 × 10.5 × 7.6

¹⁾ Use filler fitting 632004

Description

All reservoirs accept 87218 intermediate baseplate and are for direct mount.

Modular reservoirs for grease systems ^{1) 2)}					
Order number	Description	Capacity		Dimensions	
		l	gal	mm	<i>in</i>
87406	acrylic	4,90	1.30	450 × 186 × 190	17.7 × 7.3 × 7.5
87416	acrylic	7,35	1.94	641 × 186 × 190	25.2 × 7.3 × 7.5
87421 ³⁾	steel	4,90	1.30	450 × 186 × 188	17.7 × 7.3 × 7.4
87423 ³⁾	steel	7,35	1.94	641 × 186 × 188	25.7 × 7.3 × 7.4

- ¹⁾ Use filler fitting 632004
- ²⁾ Reservoirs include 1/2 NPTF (F) outlet
- ³⁾ Includes visual level indicator rod

Pump unit

PP/PPG



Description

PP pumps are air-operated, single-stroke pumps that require a 3/2-way air valve to activate the air cylinder. Designed to supply grease through one outlet, the pumps are equipped with a spring-loaded follower plate and an indicator rod for level control purposes. Suitable for indoor/outdoor applications, PP pumps have one outlet and can be used with a primary progressive metering device or with a secondary-level metering device. In comparison to the PP pumps, PPG devices include an integrated metering device with eight outlets, enabling their use as small, air-operated progressive systems.

Features and benefits

- Compact, air-operated units for up to 100 lubrication points
- Indicator rod for level control available
- Unique port arrangements possible (PPG)
- Internal return of grease into reservoir (PPG)
- Simple refilling from grease pail

Applications

- Spinning machines
- Die-cutting machines
- Beverage processing
- Small presses
- Machine tools
- Handling equipment

Technical data

Function principle	air-operated single-stroke piston pump
Operating temperature	0 to +60 °C; +32 to 140 °F
Operating pressure	
PP	300 bar, 4 350 psi
PPG	250 bar, 3 265 psi
Air inlet pressure	min. 4 bar, max. 10 bar; min. 58 psi, max 145 psi
Air pressure ratio	40:1
Lubricant	grease: up to NLGI2
Outlets	
PP	1
PPG	8
Metering quantity per stroke	
PP	2,6 cm ³ ; 0.158 in ³
PPG ¹⁾	0,2 cm ³ ; 0.012 in ³
Reservoir	0,4 oR1,5 l; 0.1 or 0.4 gal
Connection main line	
PP	for tube Ø 6mm
PPG ²⁾	M10 x 1
Connection main line	G1/8
Dimensions	
PP	115 x 122 x 550 mm 4.53 x 4.80 x 21.65 in
PPG ³⁾	115 x 112 x 725 mm 4.53 x 4.41 x 28.54 in
Mounting position	upright

¹⁾ Average output/outlet for one pump stroke: 0,3cm³/stroke; 0.018 in³/stroke

²⁾ Need to use special SKF outlet fittings

³⁾ Level indicator fully extended



NOTE

Further technical information, technical drawings, accessories, spare parts or product function descriptions are available on SKF.com/lubrication.

Pump unit

PP/PPG

Order information

Order number	Designation	Outlets	Reservoir	
			l	gal
604-29967-1	PP-4	1	0,4	0,1
604-25105-2	PP-15	1	1,5	0,4
604-29968-1	PPG-4	8	0,4	0,1
604-29969-1	PPG-4-K ¹⁾	8	0,4	0,1
604-25111-3	PPG-15	8	1,5	0,4
604-25130-3	PPG-15-K ¹⁾	8	1,5	0,4

¹⁾ K = with optical pin indicator

Accessories

Closure plug



HP/HPG accessories

Order number	Description	Tube
		Ø mm
504-30344-4	special outlet fitting	6
504-30345-2	special outlet fitting	4
303-17499-3	closure plug	–

Pump unit

PFP-23-2/PFP-23-22



Description

PFP-23-2 and PFP-23-22 are air-operated grease pump units that include a reservoir and follower plate under atmospheric pressure. These pumps are made for small-sized progressive systems or for use as multi-line pumps. The output of one lever stroke is divided by two when using two outlets. A return line to the reservoir is available. Also the pump is equipped with a filling coupler to refill the pump.

Features and benefits

- Small, compact, air-operated pump
- Up to 190 bar (2 755 psi) operating pressure
- Port for return line is available on pump
- Refill by grease coupling avoids contamination of grease
- Available with one or two outlets

Applications

- Small- and medium-sized machines
- Applications with air power supply
- Especially for indoor applications
- Die-cutting machines
- Small presses

Technical data

Function principle	air-operated piston pump
Operating temperature 1)	+10 to 60 °C; +50 to 140 °F
Operating pressure 2)	190 bar; 2 755 psi
Air inlet pressure	6-10 bar; 87-145 psi
Lubricant	grease: up to NLGI2
Outlets	
PFP-23-2:	1
PFP-23-22:	2
Metering quantity per stroke	
PFP-23-2:	outlet one closed, outlet two 2,5 cm ³ ; 0.15 in ³
PFP-23-22:	both outlets 1,25 cm ³ ; 0.076 in ³
Ratio	20:1
Reservoir 3)	1,5 l; 0.4 gal
Connection main line	
outlets	tube Ø 10mm
return line	G 1/4
Dimensions	132 × 132 × 410 mm 5.20 × 5.20 × 16.14 in
Mounting position	upright

1) For temperature below 10°C/ 50°F special version with follower piston pressurized with compressed air available, see further publication

2) Depending on air inlet pressure

3) Use filling connection order number: 995-001-500 to refill reservoir



NOTE

Further technical information, technical drawings, accessories, spare parts or product function descriptions are available on SKF.com/lubrication:

951-170-012 EN, 1-0107-4 EN

Pump unit

PFP-23-2/PFP-23-22

Order information

Order number	Description	Outlets	Metering quantity per stroke/port	
			cm ³	in ³
PFP-23-2 ¹⁾	air-operated grease pump	1	2,50	0.15
PFP-23-22	air-operated grease pump one outlet closed by plug	2	1,25	0.076

¹⁾ One outlet closed by plug

Accessories

Refill coupling

24-9909-0244



Filler socket

Order number	Description
24-9909-0244	filler socket with sealing ring

995-001-500



Coupling socket

Order number	Description
995-001-500	coupling socket for reservoir refilling

857-760-...



Hose socket

Order number	Description
857-760-007	hose socket; Ø 13 mm
857-760-002	hose socket; Ø 16 mm

Pump unit

MPB



Description

The MPB pump unit is especially designed for automatic lubrication systems. The unique feature in it compared to traditional air-operated barrel pump with mechanical air motor valve is its magnetically operated air motor valve. This will reduce the amount of mechanical components in the air motor and also eliminates the need of lubrication in the air motor. The pump is suitable for use with 18, 50 and 180 kg (40, 120 and 400 lb) lubricant barrels. And when equipped with a suitable adapter MPB pump unit can also be used in lubricant bulk containers.

Features and benefits

- Lubrication-free, electronically controlled air motor enables accurate control of pump output
- Fewer mechanical components extend a service life of the air motor
- Includes self-diagnosing system
- Operates effectively in wide range of temperatures
- IP 65 protection rating

Applications

- Paper industry
- Steel industry
- Heavy industry



Technical data

Function principle	air operated piston pump for barrels
Operating temperature	-10 to +55 °C, 14 to 131 °F
Operating pressure	max. 300 bar, 4 350 psi
Pressure ratio	1:65 or 1:20
Pressure air supply	2 to 4,5 bar, 29 to 65 psi
Air consumption	max. 300 l/min; 80 gal/min
Lubricant	grease up to NLGI 2 oil up to 20–10 000 mm ² /s
Metering quantity per cycle ¹⁾	6,1 cm ³ ; 0.20 oz
Metering quantity	max. 850 g/min; 30 oz/min (1:65) max. 1 900 g/min; 67 oz/min (1:20)
Electrical connections	20–32 V DC
Drum capacity	18, 50 and 180 kg, 40, 120 or 400 lb drum not included
Protection class	IP 65
Dimensions	
Pump 1/8	650 × 130 × 130 mm; 26 × 5 × 5 in
Pump 1/4	920 × 130 × 130 mm; 36 × 5 × 5 in
Pump 1/1	1 020 × 130 × 130 mm; 40 × 5 × 5 in
Pump tube diameter	50 mm
Air inlet fitting	8 mm, G1/4
Lubricant outlet fitting	12 mm, G1/4
Connection of the lubricant return to the reservoir	12 mm, G1/4
Niveau sonore maximal	<80 dB
Mounting position	vertical

¹⁾ generally approx. 50 cycles/min are assumed



NOTE

Further technical information, technical drawings, accessories, spare parts or product function descriptions available on SKF.com/lubrication:

PUB LS/P8 17178 EN

Pump unit

MPB

Order information

Order number	Designation	Suitable barrel size	
		kg	lb
12381702	SKF-MPB-PUMP-1/8	18	40
12381701	SKF-MPB-PUMP-1/4	50	120
12381700	SKF-MPB-PUMP-1/1	180	400

Accessories

Air regulator unit



Air regulator unit

Order number	Designation
12382666	MAX-V2-SET-MPB

Lid sets



Lid sets

Order number	Designation
12381383	MAXV2-LIDSET-1/8-ECO-MPB
12381382	MAXV2-LIDSET-1/4-ECO-MPB
12381381	MAXV2-LIDSET-1/1-ECO-MPB
12381386	MAXV2-LIDSET-1/8-STA-MPB
12381385	MAXV2-LIDSET-1/4-STA-MPB
12381384	MAXV2-LIDSET-1/1-STA-MPB

Pump unit

87212



Description

The model 87212 pump is a hydraulically operated, single-acting pump with a double-acting, hydraulic cylinder that requires a four-way valve and timer for operation. Hydraulic pressure powers the piston on the delivery stroke and returns it to priming position. Depending on the type of reservoir used, the pump is suitable for both grease and oil applications. The 87212 pump requires a specially designed reservoir that must be ordered separately.

Features and benefits

- Pump can be removed from reservoir without disturbing existing piping
- Inlet shut-off valve in reservoir base allows removal of pump without draining reservoir

Applications

- Small progressive systems
- Foundry machinery
- Material handling
- Metal cutting



Technical data

Function principle	hydraulically operated single acting pump ^{1) 3)}
Operating pressure	14-40 bar; 200-600 psi
Lubricant	oil and grease
Metering quantity ²⁾	0,164-0,98 cm ³ /stroke 0,01-0,06 in ³ /stroke
oil	max. 30 strokes/min
grease	max. 22 strokes/min
Reservoirs	see accessories
Pressure ratio	5:1
Connection main line	1/4 NPTF
Dimensions	162 × 44,5 × 44,5 mm 6,38 × 1,75 × 1,75 in
Mounting position	with reservoir upward

¹⁾ Needs to connect special reservoir to pump, see accessories

²⁾ Output adjustable by steps of one turn of adjustment screw equal to 0.049 cm³; 0.003 in³

³⁾ Pump includes NBR O-rings



NOTE

Further technical information, technical drawings, accessories, spare parts or product function descriptions available on SKF.com/lubrication.

Pump unit

87212

Order information

Order number	Description	Ratio
87212	hydraulically operated single acting pump includes NBR O-rings	5:1

Accessories

Reservoir



Description

These reservoirs made of acryl are designed to be mounted directly onto the pump. They include all connections for air (or hydraulic oil, see hydraulically driven pump 87212) and lubricant outlet. They include a gauge 200 bar; 3 000 psi and an atmospheric indicator 62 bar; 900 psi.

Modular reservoirs

Order number	Lubricant	Capacity		Connection ¹⁾ NPSM (F)	Dimensions	
		l	gal		mm	in
87402	grease	1,475	0.389	1/8	295 × 172,2 × 179,6	11.6 × 6.78 × 7.06
87403	grease	2,450	0.647	1/8	371 × 172,2 × 179,6	14.6 × 6.78 × 7.06
87405	oil	2,365	0.624	1/8	262 × 172,2 × 179,6	10.3 × 6.78 × 7.06

¹⁾ For air supply and lubricant outlet

Pump unit

87202



Description

87202 modular pumps are designed to efficiently supply grease or oil in automatic systems using metering valve metering devices. These hydraulically operated pumps must be equipped with an appropriate baseplate and reservoir to make up a pump assembly. Baseplates contain all inlet and outlet connections for the pump and lubrication system. Pump cycles will be controlled by a timer in conjunction with a four-way valve (supplied separately).

Features and benefits

- No dismantling of piping when removing pump
- No draining required due to integral check valve in baseplate
- Precise adjustability of output

Applications

- Small progressive systems
- Metal forming
- Metal cutting

Technical data

Function principle	hydraulically operated pump
Operating pressure	20-138 bar; 275-2 000 psi
Lubricant	oil and grease
Metering quantity	0,41-1,64 cm ³ /stroke 0,025-0,10 in ³ /stroke
Outlet	1
Connection main line	1/4 NPTF
Dimensions	241,3 × 47,7 × 54,1 mm 9,5 × 1,88 × 2,13 in
Mounting position	with reservoir upward



NOTE

Further technical information, technical drawings, accessories, spare parts or product function descriptions available on SKF.com/lubrication.

Pump unit

87202

Order information

Order number	Ratio	Baseplate 87218 ¹⁾	87204 ²⁾
87202	7:1	•	•

¹⁾ For use with Modular Lube reservoirs

²⁾ For machine mount, use with remote reservoir customer's supply

Accessories

Baseplate

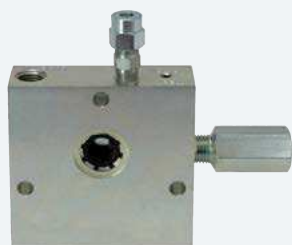
Baseplates¹⁾

Order number	Air NPTF (F) inlet	Lubricant NPTF (F) inlet	outlet
87218 ²⁾	1/8	3/8	1/4
87204 ³⁾	1/4	3/8	1/4

¹⁾ All baseplates use atmospheric indicator 100 bar; 1450 psi

²⁾ For use with Modular Lube reservoirs

³⁾ For machine mount, use with remote reservoir customer's supply

Description

Baseplates can be intermediate (for use with Modular Lube reservoirs) or machine mount (for use with remote reservoirs).

They have all main connections for hydraulic oil and lubricant included. They include FKM O-rings.

Reservoir

Modular reservoirs for oil systems¹⁾

Order number	Description	Capacity		Lubricant outlet ¹⁾ NPTF (F)	Dimensions	
		l	gal		mm	in
87400	cylindrical, acrylic	2,40	0,63	1/2	400 × 153 × 135	15.7 × 6.0 × 5.3
87413	cylindrical, acrylic	4,70	1,25	1/2	450 × 168 × 199	17.7 × 7.3 × 7.47
87417	tank, steel	18,90	5	3/8	258 × 445 × 319	10.1 × 17.5 × 12.6
87418	tank, steel	11,30	3	3/8	258 × 343 × 294	10.1 × 13.5 × 11.6
87419	tank, steel	5,70	1,50	3/8	258 267 × 192	10.1 × 10.5 × 7.6

¹⁾ Use filler fitting 632004

Description

All reservoirs accept 87218 intermediate baseplate and are for direct mount.

Modular reservoirs for grease systems^{1) 2)}

Order number	Description	Capacity		Dimensions	
		l	gal	mm	in
87406	acrylic	4,90	1,30	450 × 186 × 190	17.7 × 7.3 × 7.5
87416	acrylic	7,35	1,94	641 × 186 × 190	25.2 × 7.3 × 7.5
87421 ³⁾	steel	4,90	1,30	450 × 186 × 188	17.7 × 7.3 × 7.4
87423 ³⁾	steel	7,35	1,94	641 × 186 × 188	25.7 × 7.3 × 7.4

¹⁾ Use filler fitting 632004

²⁾ Reservoirs include 1/2 NPTF (F) outlet

³⁾ Includes visual level indicator rod

Pump unit

PHU-5/PHU-35



Description

PHU-5 and PHU-35 are hydraulically operated piston pumps for progressive systems. They are designed to supply either oil or grease. The pumps feature a spring-loaded piston that can be activated either by a 3/2-way or 4/2-way valve connection, which must be ordered separately. A reservoir can be connected to the pump via an intermediate plate or directly to the machine for a remote reservoir connection. Pump output can be modified via the adjusting screw.

Features and benefits

- Compact pump for either grease and oil
- Adjustable output via stroke setting screw
- Direct connect reservoir or remote connect reservoir possible
- Optional low-level control available, only with integrated reservoir
- Air operated version of pump available

Applications

- Small progressive systems
- Small presses

Technical data

Function principle	hydraulically operated piston pump
Operating pressure	160 bar; 2 320 psi
Actuating pressure	adjustable: 4,5-10 bar; 65-145 psi
Priming pressure	30 bar; 435 psi
Lubricant	oil and grease: up to NLGI 2
Metering quantity per stroke	
PHU-5	adjustable: 0,1-0,5 cm ³ ; 0.006-0.03 in ³
PHU-35	adjustable: 0,7-3,5 cm ³ ; 0.043-0.21 in ³
Outlet	1
Reservoir	2,5 and 5 l; 0.66 and 1.32 gal
Connection main line	M10x1 or tube Ø 10 mm
Dimensions	min. 247 × 40 × 120 mm max. 270 × 83 × 126 mm min. 9.72 × 1.57 × 4.72 in max. 10.63 × 3.27 × 4.96 in
Mounting position	any



NOTE

Further technical information, technical drawings, accessories, spare parts or product function descriptions are available on SKF.com/lubrication:

1-0107-5 EN; 951-170-012 EN

Pump unit

PHU-5/PHU-35

PHU-5 ...			
Order number	Reservoir integrated		Low-level control integrated
	l	gal	
PHU-5	no	no	no
PHU-5-2.5	2,50	0.66	no
PHU-5-2.5W	2,50	0.66	yes
PHU-5-5	5	1.32	no
PHU-5-5W	5	1.32	yes

PHU-35 ...			
Order number	Reservoir integrated		Low-level control integrated
	l	gal	
PHU-35	no	no	no
PHU-35-2.5	2,50	0.66	no
PHU-35-2.5W	2,50	0.66	yes
PHU-35-5	5	1.32	no
PHU-35-5W	5	1.32	yes

Accessories



Order number	Colour	Burst pressure		Thickness	
		bar	psi	mm	in
		PPU-BS60	black	60	870
PPU-BS80	green	80	1 160	0,203	0.008
PPU-BS100	yellow	100	1 450	0,254	0.010
PPU-BS120	red	120	1 740	0,305	0.012
PPU-BS140	orange	140	2 030	0,356	0.014
PPU-BS160	silver	160	2 320	0,406	0.016
PPU-BS180	pink	180	2 610	0.457	0.018

Pump unit

PFH-23-2/PFH-23-22



Description

PFH-23-2 and PFH-23-22 are hydraulically operated grease pump units that include a reservoir and follower plate under atmospheric pressure. These pumps are suitable for small-sized progressive systems or for use as multi-line pumps. When using two outlets, the output of one lever stroke is divided by two.

Features and benefits

- Small, compact, hydraulically operated pump
- Up to 200 bar (2 900 psi) operating pressure
- Pump port for return line is available
- Refilling via grease coupling avoids grease contamination
- Available with one or two outlets

Applications

- Small- and medium-sized machines
- Applications with hydraulic power supply
- Especially for indoor applications
- Die-cutting machines
- Small presses

Technical data

Function principle	hydraulically operated grease pump
Operating temperature	+10 to 60 °C; +50 to 140 °F
Operating pressure ¹⁾	200 bar; 2 900 psi
Air inlet pressure	6-30 bar; 87-435 psi
Lubricant	grease: up to NLGI 2
Outlets	
PHP-23-2	1
PHP-23-22	2
Metering quantity per port/stroke	
PHP-23-2	outlet one closed outlet two: 2,5 cm ³ ; 0,15 in ³ both outlets: 1,25 cm ³ ; 0,076 in ³
PHP-23-22	7:1
Pressure ratio	1,5 l; 0,4 gal
Reservoir ²⁾	
Connection main line	tube Ø 10mm
outlets	G 1/4
return line	
Dimensions	132 × 132 × 458 mm 5,20 × 5,20 × 18,03 in
Mounting position	upright

¹⁾ Depending on hydraulic inlet pressure

²⁾ Use filling connection order no. 995-001-500 to refill reservoir



NOTE

Further technical information, technical drawings, accessories, spare parts or product function descriptions are available on SKF.com/lubrication:

1-0107-4 EN; 951-170-012 EN

Pump unit

PFH-23-2/PFH-23-22

Order information

Order number	Description	Outlets	Metering quantity per stroke/port	
			cm ³	in ³
PFH-23-2 ¹⁾	hydraulically operated grease pump	1	2,50	0.15
PFH-23-22	hydraulically operated grease pump	2	1,25	0.076

¹⁾ One outlet closed by plug

Accessories

Refill coupling

24-9909-0244



Filler socket

Order number	Description
24-9909-0244	filler socket with sealing ring

995-001-500



Coupling socket

Order number	Description
995-001-500	coupling socket for reservoir refilling

857-760-...



Hose socket

Order number	Description
857-760-007	hose socket; Ø 13 mm
857-760-002	hose socket; Ø 16 mm

Pump unit

MCLP



Description

MCLP pumps are designed to supply oil under high pressure to a distribution circuit of progressive metering devices connected downstream. They include two main parts – the MCLP gearbox containing the lubrication oil and the MCLP pump heads. The gearbox can hold up to two pump heads. By the action of a cam in the gearbox, the pump plunger is pushed upward on the delivery stroke and returned to priming position by the plunger return spring. The cam can be actuated by an electrical motor or by connection to a machine. The cam of all pump models has a single lobe for pump head actuation.

Features and benefits

- two sizes of pump heads available
- Fully adjustable output
- Driven by machine or electric motor (supplied separately)
- Various gear ratios available

Applications

- Applications with high pressure
- Natural gas engines
- Refineries
- Compressors

Technical data

Function principle	free shaft-end piston pump
Operating temperature	-18 to +94 °C; 0 to +200 °F
Operating pressure	
pump head 7 mm:	max. 550 bar; max. 8 000 psi
pump head 10 mm:	max. 240 bar; max. 3 500 psi
Relief pressure	
pump head 7 mm:	max. 375 bar; max. 5 500 psi
pump head 10 mm:	max. 220 bar; max. 3 250 psi
Inlet pressure	max. 3,5 bar; max. 50 psi
Lubricant	oil: 20–1 500 mm ² /s
Outlets	1 -2
Metering quantity per stroke	
pump head 7 mm:	0,033–0,24 cm ³ ; 0.002–0.015 in ³
pump head 10 mm:	0,07–0,49 cm ³ ; 0.004–0.03 in ³
Reservoir	1,5 l; 0.4 gal
Drive speed	12 to 75 min ⁻¹
Internal gear ratio	2:1, 4:1, 8:1, 21.5:1
Connection main line	
inlet	3/8 NPTF (F)
outlet	1/4 NPTF (F)
Dimensions	258 × 206 × 343 mm 10.19 × 8.13 × 13.50 in
Mounting position	upside up



NOTE

Further technical information, technical drawings, accessories, spare parts or product function descriptions are available on SKF.com/lubrication.

Pump unit

MCLP

Order information

Order number	Drive position	Gear ratio	Pump head
130201BCC	right, long shaft	2:1	2, including two pump heads, model number R130335
130200GEE	right	8:1	–, to be ordered separately
130200DEE	right	4:1	–, to be ordered separately
130300GEE	left	8:1	–, to be ordered separately

Accessories

MCLP pump heads



MCLP pump heads

MCLP Pump heads are fitted to the MCLP gear box. Up to two pump heads can be used.

MCLP pump heads

Order number	Piston
	Ø mm
130332	7
130335	10

MCLP pump inlet filter



MCLP pump inlet filter

This MCLP pump inlet filter serves two pump heads. It filters the oil, from the header tank, before entering the pump heads with filter size 10 µm.

MCLP pump inlet filter

Order number	Inlet	Inlet pressure max.	
		bar	psi
130067	1	3,5	50

MCLP pump heads



In-line filter

Filter used at the outlet of the pump heads to remove solid contaminants before delivering lubricants to the supply line. Uses filtering element size 10 µm. Has a hexbody size 1 1/4 in and includes FKM seal.

In-line filter

Order number	Inlet	Inlet pressure max.	
		bar	psi
84239	1/4	415	6 000

MCLP pump heads



No-flow valve

MCLP Pump heads are fitted to the MCLP gear box. Up to two pump heads can be used.

No-flow valve

Order number	Operating pressure max.		Air supply max.	
	bar	psi	bar	psi
87862	415	6 000	10	150

Pump unit

HP/HPG



Description

The manually operated single-stroke lever pump HP is designed for use in progressive systems to supply grease through one outlet. They are equipped with a spring-loaded follower plate and an indicator rod for level control purposes. The pumps can be used with a primary progressive metering device only or also with a secondary-level metering device. Similar to HP pumps, HPG pumps include a special integrated progressive metering device with eight outlets. Therefore, the HPG are suitable for small manually operated progressive systems.

Features and benefits

- No power supply necessary
- Ease of use
- HPG with integrated progressive metering device, serving up to 8 lubrication points
- HPG15 pumps refillable via filling nipple
- Level control via indicator rod

Applications

- Applications without power supply
- Indoor use
- Excenter presses
- Slurry centrifuges



Technical data

Function principle	manually operated single-stroke piston pump
Operating temperature	-25 to +70 °C; -13 to +158 °F
Operating pressure	250 bar, 3 625 psi
Lubricant	grease: up to NLGI 2
Outlets	1-8
Metering quantity per stroke	1,6 cm ³ ; 0.10 in ³
Reservoir	
HP 4/ HPG 4	0,4 l; 0.1 gal
HP15 / HPG 15	1,5 l; 0.4 gal
Connection main line ¹⁾	for tube Ø 6mm; M10×1
Dimensions ²⁾	min. 73 × 110 × 350 mm max. 107 × 180 × 455 mm min. 2.87 × 5.15 × 21.65 in max. 4.21 × 7.09 × 19.91 in
Mounting position	upright

¹⁾ Need to use special outlet fittings

²⁾ Add approx. 153 mm for depth and 85 mm for height for full extension of lever and level rod



NOTE

Further technical information, technical drawings, accessories, spare parts or product function descriptions are available on SKF.com/lubrication:

951-231-000-EN

Pump unit

HP/HPG

Order information

Order number	Designation	Outlet	Operating pressure	
			bar	psi
604-25102-1	HP 4	1	250	3 625
604-25103-1	HP 15	8	250	3 625
604-25108-2	HPG 4	8	200	2 900
604-25109-2	HPG 15	8	200	2 900
604-25128-2	HPG 15-K1)	8	200	2 900

Accessories

303-17499-3



HP/HPG Closure plug

Order number	Description
303-17499-3	closure plug to reduce number of outlets

Description

HP pump type is delivered with outlet fittings for tube \varnothing 6 mm. Special outlet connection fittings need to be used for pump model HPG. The closure plugs allow it to adapt the number of outlets.

The output is then a multiple of 0,2 cm³; 0.012 in³.

HP/HPG Outlet fittings

Order number	Description	Tube
		\varnothing mm
504-30344-4	outlet check valve assembly	6
504-30345-2	outlet check valve assembly	4

Pump unit

HP-500 W/HP-500 W-SSV

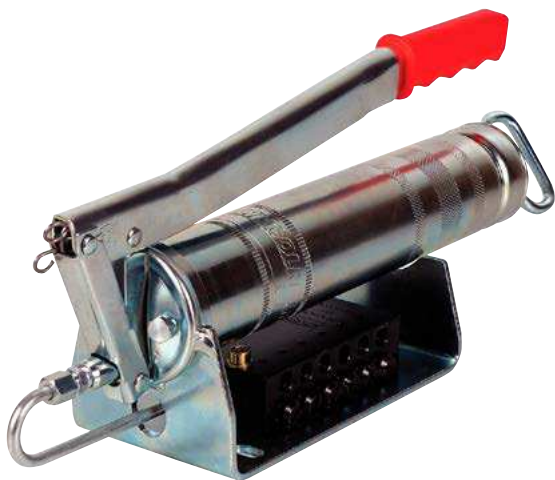

Description

The manually operated, single-stroke HP-500W pump is designed to be affixed vertically on a wall. The pump can supply grease directly to lubrication points or can be connected to progressive metering devices for an even supply of lubricant.

The HP 500W-SSV version of the pump features an integrated metering device with various outlet numbers. Both models may be used with bulk grease or with standard 400 g (0.88 lb) cartridges.

Features and benefits

- Uses standard cartridges
- No electrical power supply necessary
- Refillable bulk reservoir
- Easy to use
- Available with or without integrated metering device

Applications

- Applications without power supply
- Indoor use
- Printing industry
- Punching machines
- Planing machines

Technical data

Function principle	manually operated single-stroke piston pump
Operating temperature	-25 to +70 °C; -13 to +158 °F
Operating pressure	
HP-500W	400 bar, 5 800 psi
HP-500W SSV	350 bar, 3 625 psi
Lubricant	grease: up to NLGI 2
Outlet	
HP-500W	1
HP-500W SSV	6, 8, 10, 12
Metering quantity	
HP-500W	per stroke: 1,5 cm ³ ; 0.09 in ³
HP-500W SSV	per SSV outlet: 0,2 cm ³ ; 0.012 in ³
Reservoir	
with cartridge	0,4 l; 0.11 gal
without cartridge	0,5 l; 0.13 gal
Connection main line ¹⁾	M 10 × 1 ¹⁾
Dimensions ²⁾	
HP-500W	95 × 165 × 380 mm 3.74 × 6.50 × 14.96 in
HP-500W SSV	95 × 165 × 405 mm 3.74 × 6.50 × 15.94 in
Mounting position	upright

¹⁾ Need to use special outlet fittings

²⁾ Add approx. 195 mm for depth and 210 mm for height for full extension of lever and level rod



NOTE

Further technical information, technical drawings, accessories, spare parts or product function descriptions are available on SKF.com/lubrication:

951-231-000-EN

Pump unit

HP-500 W/HP-500 W-SSV

Order information

Order number	Designation	Outlet	Metering device
244-14164-1	HP-500 W	1	–
604-28766-1	HP-500W-SSV 6	6	•
604-28767-1	HP-500W-SSV 8	8	•
604-28768-1	HP-500W-SSV 10	10	•
604-28769-1	HP-500W-SSV 12	12	•

Accessories

303-17499-3



HP/HPG Closure plug

Order number	Description
303-17499-3	closure plug to reduce number of outlets

Description

HP pump type is delivered with outlet fittings for tube \varnothing 6 mm. Special outlet connection fittings need to be used for pump model HPG. The closure plugs allow it to adapt the number of outlets.

The output is then a multiple of 0,2 cm³; 0.012 in³.

HP/HPG Outlet fittings

Order number	Description	Tube
		\varnothing mm
504-30344-4	outlet check valve assembly	6
504-30345-2	outlet check valve assembly	4

Pump unit

PF-VPBM/169-000-146



Description

The manually operated PF-VPBM pump was developed to supply lubricant from a grease cartridge. Equipped with an integrated metering device, the easy-to-use pump is suitable for applications requiring a compact progressive system. Its size can vary from six to 12 outlets that supply even amounts of lubricant.

The PF-VPBM version of the pump features an integrated metering device with various outlet numbers. Both models may be used with bulk grease or with standard 400 g (0.88 lb) cartridges.

Features and benefits

- Reliable, user-friendly pump
- Utilizes grease cartridges for convenience
- Varying number of outlets available

Applications

- Farm machinery
- Small stackers
- Construction machinery
- Motor vehicle superstructures

Technical data

Function principle	manually operated piston pump
Operating temperature	-25 to +80 °C; -13 to +180 °F
Operating pressure	400 bar, 5 800 psi
Lubricant	grease: up to NLGI 2
Outlets	6-12
Metering quantity	per lever stroke without metering device: 2,0 cm ³ ; 0.12 in ³
Reservoir	450 cm ³ in 400 g cartridge 27.46 in ³ in 0.88 lbs cartridge
Connection main line Dimensions ²⁾	outlet fitting: M10 x 1
HP-500W	min. 140 x 156 x 396 mm max. 140 x 156 x 506 mm
HP-500W SSV	min. 5.51 x 6.14 x 15.59 in max. 5.51 x 6.14 x 19.92 in
Mounting position	any

¹⁾ pump available with one outlet, without block metering device

²⁾ add approx. 244 mm, 9.6 in for depth and 415 mm; 16.3 in for height for full extension of lever and level rod



NOTE

Further technical information, technical drawings, accessories, spare parts or product function descriptions are available on SKF.com/lubrication:

1-9430-EN, 951-230-008-EN

Pump unit

PF-VPBM/169-000-146

Order information

Order number	Outlet	Metering device
169-000-146	1	–
PF-VPBM-3-2	6	•
PF-VPBM-4-2	8	•
PF-VPBM-5-2	10	•
PF-VPBM-6-2	12	•

Accessories

Outlet fitting



PF-VPBM accessories

Order number	Description	Tube
		Ø mm
VPKM-RV-S4	outlet fitting with check valve	6
VPKM-RV-VS	push-in fitting	6
917-006-101	closure plug	

Pump unit

HJ 2



Description

The manually operated HJ 2 pump unit was developed to provide lubricant to points that do not require continuous lubrication. Comprising of two supply pistons and a 3 liter (0.8 gal) reservoir with an integrated stirring device, this robust pump unit operates effectively, even at low temperatures. Operating pressure is 300 bar (4 350 psi).

Features and benefits

- Suitable for use with dual-line or progressive systems
- Dispenses greases up to NLGI 3
- Available with left- or right-hand lever

Applications

- Metal forming
- Roll straighteners
- Tire heating presses
- Harbor cranes

Technical data

Function principle	manually operated doubler stroke piston pump
Operating temperature	-20 to +70 °Cxxxx; -4 to +160 °F
Operating pressure	max. 300 bar, 4 350 psi
Lubricant	grease: up to NLGI 3; depending on operating temperature oil: with a viscosity minimum 150 mm ² /s at operating temperature
Outlets	up to 2
Metering quantity	HJ 2: 2 cm ³ , 0.122 in ³ HJ 2A: 2x 1 cm ³ , 0.061 in ³
Reservoir	3 l; 0.8 gal
Connection main line	G1/4
Dimensions	410 × 135 × 393 mm 16.1 × 5.5 × 15.5 in
Mounting position	upright



NOTE

Further technical information, technical drawings, accessories, spare parts or product function descriptions are available on SKF.com/lubrication.

Pump unit

HJ 2

Order information

Order number	Designation	Position hand lever	Outlets
603-41200-1	HJ 2 R-3 XYN	right	1
603-41200-2	HJ 2 L-3 XYN	left	1
603-41200-3	HJ2AR- 3XYN	right	2
603-41200-4	HJ2AL- 3XYN	left	2

Accessories

223-13052-1



223-13052-2



Outlet fitting with integrated check valve

Order number	Designation	Tube
		Ø mm
223-13052-1	GERV 6-S G 1/4 AVCF	6
223-13052-2	GERV 8-L G 1/4 AVCF	8
223-13052-3	GERV 10-L G 1/4 AVCF	10

Note: must be ordered with pump

Pump unit

PF-23-2/PF-23-22

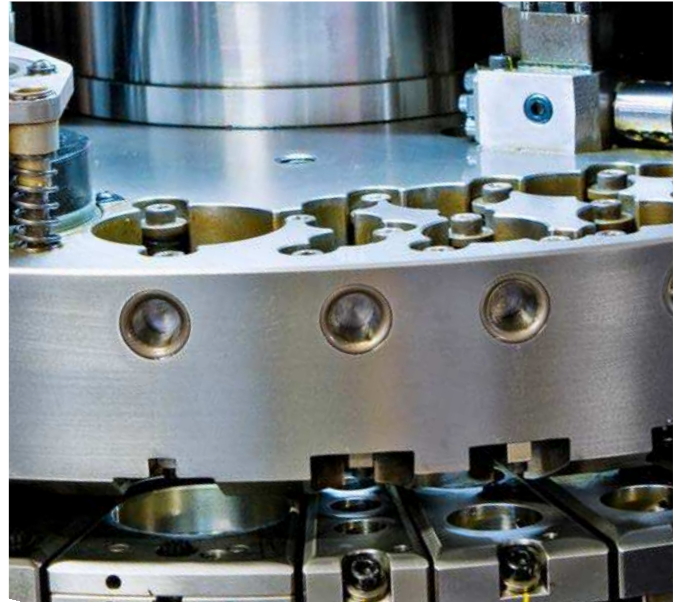

Description

PF-23-2 and PF-23-22 are manually operated grease pump units that include a reservoir and follower plate under atmospheric pressure. These pumps are made for small-sized progressive systems or for use as multi-line pumps. When using two outlets, the output of one lever stroke is divided by two. A return line to the reservoir is available. Also, these pumps are equipped with a filling coupler for replenishing the reservoir.

Features and benefits

- Small, compact, manually operated pump
- Up to 100 bar operating pressure
- Pump inlet for return line is available
- Refilling via grease coupler avoids grease contamination
- Available with one or two outlets

Applications

- Small- and medium-sized machines
- Applications where no power supply is available
- Especially for indoor applications
- Excenter presses
- Punching machines

Technical data

Function principle	manually operated single stroke piston pump
Operating temperature	+10 to 60 °C; +50 to 140 °F
Operating pressure at 200 N manual force:	100 bar; 1 450 psi
Lubricant	grease: up to NLGI 2
Outlets	
PF-23-2	1
PF-23-22	2
Metering quantity per stroke	
PHP-23-2	outlet one closed outlet two: 2,5 cm ³ ; 0.15 in ³ both outlets: 1,25 cm ³ ; 0.076 in ³
PHP-23-22	1,5 l; 0.4 gal
Reservoir	acryl glass
Material reservoir	
Connection main line	
outlets	tube Ø 10mm
return line	G 1/4
Dimensions	185 × 130 × 397 mm 7.28 × 5.12 × 15.63 in
Mounting position	upright



NOTE

Further technical information, technical drawings, accessories, spare parts or product function descriptions are available on SKF.com/lubrication:

951-170-012 EN, 1-0107-4-EN

Pump unit

PF-23-2/PF-23-22

Order information

Order number	Outlets	Metering quantity	
		cm ³ /stroke	in ³ /stroke
PF-23-2 ¹⁾	1	2,50	0.150
PF-23-22	2	1,25	0.076

¹⁾ One outlet closed by plug

Accessories

Refill coupling

24-9909-0244



Filler socket

Order number	Description
24-9909-0244	filler socket with sealing ring

995-001-500



Coupling socket

Order number	Description
995-001-500	coupling socket for reservoir refilling

857-760-...



Hose socket

Order number	Description
857-760-007	hose socket; Ø 13 mm
857-760-002	hose socket; Ø 16 mm

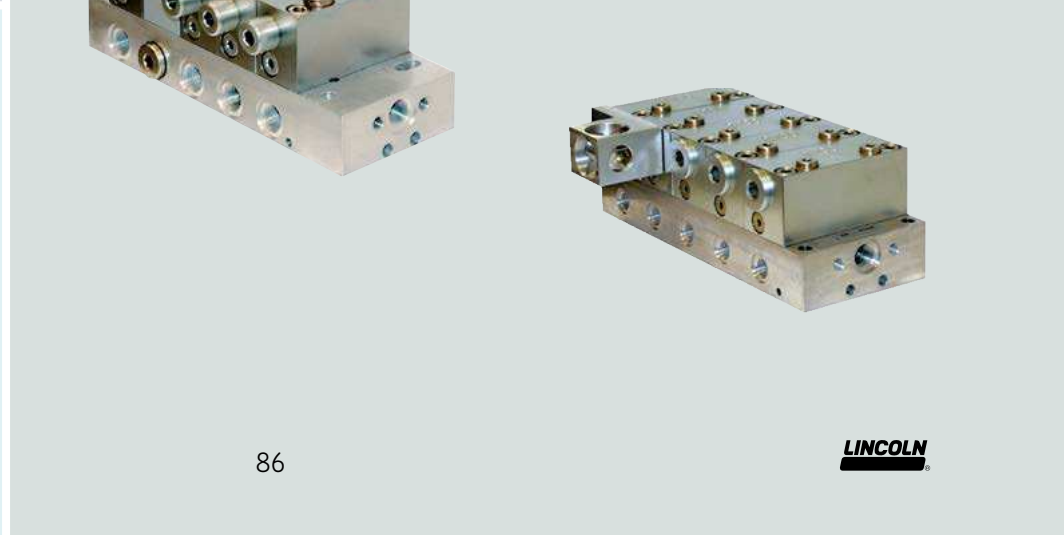
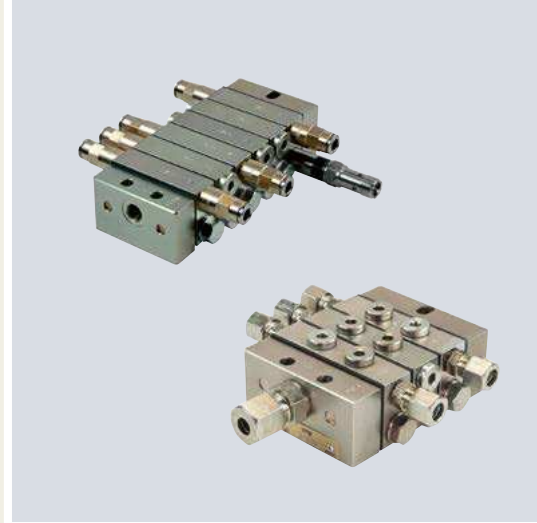

Overview of metering devices

Block metering device

Product	Lubricant Oil/ fluid grease	Grease	Metering quantity		Outlets ¹⁾	Operating pressure max.		Page
			cm ³ /outlet	in ³ /outlet		bar	psi	
SSVM	•	•	0,07	0.004	6 to 12	200	2 900	88
SSVD	•	•	0,08–1,80	0.005–0.11	6 to 22	350	5 075	90
SSVDL	•	•	0,08–1,80	0.005–0.11	6 to 14	350	5 075	94
SPVS	•	•	0,16–0,32	0.010–0.02	2 to 4	100	1 450	96
VPB	•	•	0,2	0.01	6 to 20	300	4 350	98
SSV	•	•	0,2	0.01	6 to 22	350	5 075	100
SSVL	•	•	0,2	0.01	6 to 14	350	5 075	104

¹⁾ By crossporting or closing outlets possible to reduce outlet number below given minimum

Sectional metering device

Product	Lubricant Oil/ fluid grease	Grease	Metering quantity		Outlets	Operating pressure max.		Page
			cm ³ /outlet	in ³ /outlet		bar	psi	
VPK	•	•	0,050–0,600	0.003–0.037	6 to 20	300	4 350	106
VP	•	•	0,100–1,200	0.006–0.073	6 to 20	300	4 350	110

Segment metering device

Product	Lubricant Oil/ fluid grease	Grease	Metering quantity		Outlets ¹⁾	Operating pressure max.		Page
			cm ³ /outlet	in ³ /outlet		bar	psi	
PSG1	•	•	0,050–0,250	0.003–0.015	6 to 20	200	2 900	114
PSG2	•	•	0,060–0,840	0.003–0.051	6 to 20	200	2 900	116
PSG3	•	•	0,800–3,200	0.049–0.195	6 to 20	200	2 900	118
UV	•	•	0,164–0,656	0.010–0.040	6 to 16	240	3 480	120
MC ² -HP	•	•	0,196–0,393	0.012–0.024	6 to 16	510	7 425	122
XL	•	•	0,983–2,460	0.060–0.150	6 to 12	170	2 495	124

Lubrication pinions

Product	Lubricant Oil/ fluid grease	Grease	Flow rate max.		Modules	Operating pressure max.		Page
			cm ³ /min	in ³ /outlet		bar	psi	
LP2	–	•	2 000	122	12 to 24	150	2 175	126

Metering device

SSVM



Description

SSVM type metering device is a compact single block progressive piston-type metering device. For direct mount of fittings with no need of any sealing in-between. Specially designed for small output needs, small spaces due to its small dimensions and short distances. Available with pin indicator for visual system monitoring.

Features and benefits

- Small and compact size for applications where space is restricted
- Internal combining of outlets
- Exact lubricant metering
- Available with visual pin indicator

Applications

- Printing industry
- Wood processing machines
- Material handling machines

Technical data

Function principle	block metering device
Outlets ¹⁾	6 to 12
Lubricant grease:	up to NLGI 2
oil:	at least 40 mm ² /s
Metering quantity per cycle and outlet:	0,07 cm ³ ; 0,0043 in ³
Connection inlet	G 1/8 or R 1/8 NPTF
Connection outlet ²⁾	M 8 x 1
Operating temperature	-25 to +70 °C; -13 to +158 °F
Operating pressure	max. 200 bar; 2 900 psi
Material	black chromated steel
Dimensions	min. 48,50 x 50 x 25 mm max. 83 x 50 x 25 mm min. 1.91 x 1.97 x 0.98 in max. 3.27 x 1.97 x 0.98 in
Mounting position	any

¹⁾ By crossporting or closing outlets possible to reduce outlet number below given minimum. Outlet #1 and #2 should never be closed
²⁾ Use special SSVM outlet fittings

NOTE

Further technical information, technical drawings, accessories, spare parts or product function descriptions are available on SKF.com/lubrication.

Metering device

SSVM

Order information

Order number	Inlet connection thread	Inlet connection thread	Outlets	Visual pin indicator	Material
	BSP	NPTF		K	black chromated steel
619-26761-1		619-26764-1	6	–	•
619-37044-1		619-26650-1	8	–	•
619-26846-1		619-26848-1	10	–	•
619-37049-1		619-26653-1	12	–	•
619-26762-3		619-26765-3	6	•	•
619-37045-3		619-26651-3	8	•	•
619-26847-2		619-26849-3	10	•	•
619-37050-3		619-26654-3	12	•	•

Accessories

Outlet fittings, screw type SSVM

Order number	Description	Material	Tube
			Ø mm
519-31661-1	check valve assembly	steel, black chromated	4

519-31661-1



Outlet fittings, screw-type without check valve¹⁾

Order number	Description	Material	Tube
			Ø mm
419-22604-2	coupling screw	steel, black chromated	4
419-22603-4	sealing and clamping ring	steel, black chromated	4

Outlet closure plug for internal combining of outlets

Order number	Description
303-16284-1	outlet closure plug with sealing edge

¹⁾ Only for plastic tube in low pressure applications

Outlet fittings, push-in type

Order number	Designation	Material	Tube	Connection
			Ø mm	
226-14091-5	RV 6511-4-M8x1-S02 valve body with clamping ring	brass, nickel-plated	4	plastic tube

Metering device

SSVD



Description

SSVD type metering device is a compact single block progressive metering device with adjustable output by means of different metering screw sizes. The screw meters the output for a pair of outlets (opposite outlets). For direct mount of fittings with no need of any sealing in-between. It is a versatile metering device available in many variants regarding type of monitoring or surface treatment.

Features and benefits

- Ten different metering screw sizes available
- Optionally visual or electrical monitoring
- Nickel plated surface treatment for corrosive environment available
- Ideal for use as primary metering device

Applications

- Construction and mining
- Farm machinery
- Industrial equipment

Technical data

Function principle	block metering device
Operating temperature	-25 to +70 °C; -13 to +158 °F
Operating pressure	max. 350 bar; 5 075 psi
Outlets ¹⁾	6 to 22
Lubricant	
grease:	up to NLGI 2
oil:	at least 40 mm ² /s
Metering quantity ²⁾	
per cycle and outlet:	min. 0,08 cm ³ ; 0.0042 in ³ max. 1,80 cm ³ ; 0.11 in ³
Connection inlet	G 1/8 oR 1/8 NPTF
Connection outlet ³⁾	M10x1
Material	black chromated steel or nickel plated
Dimensions	min. 70 x 60 x 40 mm max. 190 x 60 x 40 mm min. 2.75 x 2.36 x 1.57 in max. 7.48 x 2.36 x 1.57 in
Mounting position	any

¹⁾ By crossporting or closing outlets possible to reduce outlet number below given minimum. Outlet #1 and #2 should never be closed
²⁾ Depending on metering screw valid for a pair of opposite outlets
³⁾ Use special SSVD outlet fittings

NOTE

Further technical information, technical drawings, accessories, spare parts or product function descriptions are available on SKF.com/lubrication:

12401 EN

Metering device

SSVD

Order information ¹⁾

Outlets	Order number Standard	Visual pin K	Emergency nipple E	Piston detector, cable (3 m, 9.8 ft) no plug N	Indicator pin, proximity switch, cable (2 m, 6.6 ft), no plug KN	Piston detector, with connection M12, 3 wire NP
---------	--------------------------	-----------------	--------------------------	--	--	---

SSVD BSPP, black chromated

6	649-29485-1	649-29505-1	649-77394-1	649-29495-1	649-29515-1	649-29525-1
8	649-29486-1	649-29506-1	649-77395-1	649-29496-1	649-29516-1	649-29526-1
10	649-29487-1	649-29507-1	649-77396-1	649-29497-1	649-29517-1	649-29527-1
12	649-29488-1	649-29508-1	649-77397-1	649-29498-1	649-29518-1	649-29528-1
14	649-29489-1	649-29509-1	649-77398-1	649-29499-1	649-29519-1	649-29529-1
16	649-29587-1	649-29595-1	649-77399-1	649-29611-1	649-29603-1	649-29619-1
18	649-29588-1	649-29596-1	649-77400-1	649-29612-1	649-29604-1	649-29620-1
20	649-29589-1	649-29597-1	649-77401-1	649-29613-1	649-29605-1	649-29621-1
22	649-29590-1	649-29598-1	649-77402-1	649-29614-1	649-29606-1	649-29622-1

SSVD NPTF, black chromated

6	649-29535-1	649-29545-1	–	649-29565-1	649-29555-1	649-29575-1
8	649-29536-1	649-29546-1	–	649-29566-1	649-29556-1	649-29576-1
10	649-29537-1	649-29547-1	–	649-29567-1	649-29557-1	649-29577-1
12	649-29538-1	649-29548-1	–	649-29568-1	649-29558-1	649-29578-1
14	649-29539-1	649-29549-1	–	649-29569-1	649-29559-1	649-29579-1
16	649-29627-1	649-29635-1	–	649-29651-1	649-29643-1	649-29659-1
18	649-29628-1	649-29636-1	–	649-29652-1	649-29644-1	649-29660-1
20	649-29629-1	649-29637-1	–	649-29653-1	649-29645-1	649-29661-1
22	649-29630-1	649-29638-1	–	649-29654-1	649-29646-1	649-29662-1

SSVD BSPP, nickel plated

6	649-77180-1	649-77853-1	–	–	–	–
8	649-77181-1	649-77854-1	–	–	–	–
10	649-77182-1	649-77855-1	–	–	–	–
12	649-77183-1	649-77856-1	–	–	–	–
14	649-77184-1	649-77857-1	–	–	–	–
16	649-77185-1	649-77858-1	–	–	–	–
18	649-77186-1	649-77859-1	–	–	–	–
20	649-77187-1	649-77852-1	–	–	–	–
22	649-77188-1	649-77860-1	–	–	–	–

¹⁾ SSVD also with emergency lubrication nipple available

Accessories

Metering adjustment screws

Order number ^{1) 2)}		Code	Output	
Single product	Bag of 12		cm ³	in ³
303-16118-1	549-34254-1	A	0,08	0.0049
303-16119-1	549-34254-2	B	0,14	0.0085
303-16120-1	549-34254-3	C	0,20	0.012
303-16121-1	549-34254-4	D	0,30	0.018
303-16122-1	549-34254-5	E	0,40	0.024
303-16123-1	549-34254-6	F	0,60	0.037
303-16124-1	549-34254-7	G	0,80	0.049
303-16125-1	549-34254-8	H	1,00	0.061
303-16126-1	549-34254-9	I	1,40	0.085
303-16127-1	549-34255-1	J	1,80	0.110

¹⁾ For black chromated SSVD; for nickel plated SSVD ask for metering screws in stainless steel

²⁾ 549-34255-2 a Bag of 2 pcs. each

Accessories

SSVD

Outlet fittings, push-in type; valve body with clamping ring

Order number	Designation	Material	Tube	Connection
			Ø mm	
226-14091-6	RV 6511-4-M10x1-S02	brass, nickel-plated	4	plastic tube
226-14091-4	RVM 6511-6M10x1-S01	brass, nickel-plated	6	plastic tube hose stud with groove
226-14091-2	RV 6511-6-M10x1-S01	brass, nickel-plated	6	plastic tube
226-14091-8	WRVM 6521-6-M10x1 valve body 90°	brass, nickel-plated	6	plastic tube hose stud with groove
226-14091-9	WRV 6511-6-M10x1 valve body 90°	brass, nickel-plated	6	plastic tube

226-14091-8



Outlet fittings, screw type

Order number	Description	Material	Tube
			Ø mm
504-30345-2	check valve assembly	steel, black chromated	4
504-30344-4	check valve assembly	steel, black chromated	6
504-31864-1	check valve assembly	steel, black chromated	8
504-31863-1	check valve assembly	steel, black chromated	8
504-31709-1	check valve assembly	stainless steel, 1.4571	4
504-31705-1	check valve assembly	stainless steel, 1.4571	6

226-14091-4



Outlet closure plug

Order number	Description
303-17499-3	outlet closure plug with sealing edge, steel
303-19346-2	outlet closure plug with sealing edge, stainless steel
219-13798-3	O-ring for stainless steel closure plug; if after tightening with 18 Nm not sealed

303-17499-3



Outlet combining element

Order number	Description	Material	Tube
			Ø mm
519-31826-1	external outlet combining element for outlets 1 and 2	steel, black chromated	6

519-31826-1



Accessories

SSVD

Universal piston detector

Order number	Description
234-13163-9	universal piston detector 10-35 VDC
234-11454-1	bipolar piston detector
419-74031-1	adapter SSV/SSVD
237-13442-4	plug
237-13442-6	90° plug with cable 5 m (16.5 ft)
236-10022-7	straight plug with cable 10 m (33 ft)

Piston detector with cable

Order number	Description
664-85282-7	piston detector with cable; 3 m (10 ft)
664-85282-6	piston detector stainless steel with cable; 3 m (10 ft)
664-85282-8	piston detector with cable; 5 m (16.5 ft)

Piston detector with cable and bayonet plug

Order number	Description
664-85242-2	piston detector with cable; 3 m (10 ft); bayonet plug
664-85242-5	piston detector with cable; 7 m (23 ft); bayonet plug

Pressure indicating units for SSVD

Order number	Description	Pressure	
		bar	psi
532-60073-1	pressure indicator assembly	50	725
532-60075-1	pressure indicator assembly	200	2 900
532-60085-1	pressure indicator assembly	270	3 915

Accessories for proximity switch KS

Order number	Description
519-36713-7	limit switch with accessories
236-13281-2	limit switch V3S+VL1

Accessories for proximity switch KN

Order number	Description
234-10812-8	proximity switch PNP, 10-30 VDC,
234-13134-5	proximity switch NPN, 10-30 VDC
519-30911-1	adapter with stop ring

Pressure checking set

Order number	Description
604-36879-1	set for checking pressure and function

Special screw driver

Order number	Description
404-22614-1	special screwdriver for closure plugs on SSV metering devices

Bracket SSVD

Order number	Description	Material
449-70906-1	bracket for SSVD	steel, galvanized

449-70906-1

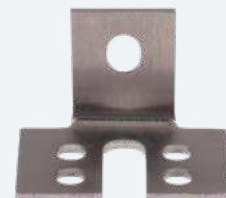

Metering device

SSVDL



Description

SSVDL type metering device is a single block progressive metering device with larger tube diameters especially for heavy industry applications. Available with pin indicator for visual system monitoring or with piston detector for electrical system monitoring. Outlet combining elements for 2, 3, 4 and 5 outlets available.

Features and benefits

- Similar to SSVD but with larger distances between the outlets for larger tube diameters
- Sizes 6 to 14 outlets
High operating pressure
- Exact lubricant metering
- Optionally equipped with visual monitoring pin or with electrically monitored piston detector

Applications

- Heavy industry



Technical data

Function principle	block metering device
Operating temperature	-25 to +75 °C; -13 to +167 °F
Operating pressure	max. 350 bar; 5 075 psi
Outlets ¹⁾	6 to 14
Lubricant	
grease:	up to NLGI 2
oil:	minimum 40 mm ² /s
Metering quantity per cycle and outlet:	min. 0,08 cm ³ ; 0,0042 in ³ max. 1,80 cm ³ ; 0,11 in ³
Connection inlet	R1/4
Connection outlet	8, 10 oR12 mm
Material	black chromated steel
Dimensions	min. 110 × 60 × 50 mm max. 230 × 60 × 50 mm min. 4.33 × 2.36 × 1.97 in max. 9.05 × 2.36 × 1.97 in
Mounting position	any

¹⁾ To ensure metering device operation outlet 1 and 2 should never be closed by a closure plug



NOTE

Further technical information, technical drawings, accessories, spare parts or product function descriptions are available on SKF.com/lubrication:

12401 EN

Metering device

SSVDL

SSVDL

Outlets	Order number Standard	Visual pin	with bypass bore
6	649-77167-1	649-77474-1	649-77464-1
8	649-77168-1	649-77475-1	649-77466-1
10	649-77169-1	649-77476-1	649-77468-1
12	649-77170-1	649-77477-1	649-77470-1
14	649-77171-1	649-77478-1	649-77472-1

Accessories

Connecting bars

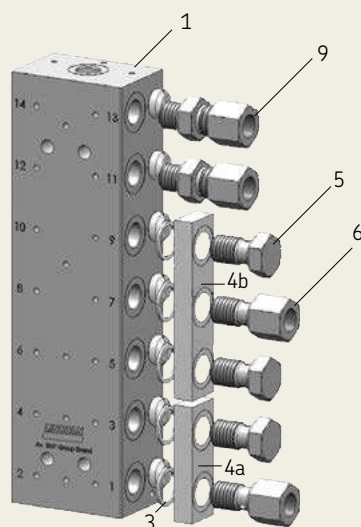

Connecting bars (item 4), steel chromated

Order number	Description
519-34643-1	double, assembly (incl. pos. 2 × 3, 1 × 5)
519-34643-2	triple, assembly (incl. pos. 3 × 3, 2 × 5)
519-34643-3	quadruple, assembly (incl. pos. 4 × 3, 3 × 5)
519-34643-4	quintuple, assembly (incl. pos. 5 × 3, 4 × 5)

Accessories for combining outlets (item 6)

Order number	Description	Tube	Material
		Ø mm	
504-33659-1	check valve	8	steel chromated
504-33660-1	check valve	10	steel chromated
504-33661-1	check valve	12	steel chromated

Metering adjustment screws

Order number ¹⁾		Code	Metering quantity	
Single product	Set (12 pieces)		cm ³	in ³
303-16118-1	549-34254-1	A	0,08	0.0049
303-16119-1	549-34254-2	B	0,14	0.0085
303-16120-1	549-34254-3	C	0,20	0.012
303-16121-1	549-34254-4	D	0,30	0.018
303-16122-1	549-34254-5	E	0,40	0.024
303-16123-1	549-34254-6	F	0,60	0.037
303-16124-1	549-34254-7	G	0,80	0.049
303-16125-1	549-34254-8	H	1,00	0.061
303-16126-1	549-34254-9	I	1,40	0.085
303-16127-1	549-34255-1	J	1,80	0.110
	549-34255-2 ²⁾			

¹⁾ For black chromated SSVD; for nickel plated SSVD ask for metering screws in stainless steel
²⁾ Set of 2 pieces

Single parts for combining outlets

Order number	Description	Material
303-16470-1	closure plug G1/4 (item 5)	steel, black chromated
220-12238-9	sealing ring (item 3)	NBR

Outlet tube fittings with check valve (item 9)

Order number	Designation	Tube
		Ø mm
223-13052-2	GERV 8 LR 1/4 V	8
223-13052-3	GERV 10 LR 1/4 V	10
223-13052-5	GERV 12 LR 1/4 V	12

Metering device

SPVS



Description

Block type metering devices of the SPVS series are used to either increase the number of outlets of a lubricating pump or to portion the volume flow and deliver it to the lube points, without any influence on the operating system pressure.

Features and benefits

- Compact design
- Compact two piston version with mechanical interlock, prevents selfblockage
- Universally usable for oil and grease
- Central function monitoring with electrical stroke monitoring device possible
- Accurate lubricant distribution due to fitted pistons

Applications

- Metal forming machines
- Small machinery
- Packaging machines

Technical data

Function principle	block metering device
Operating temperature ²⁾	-10 to +100 °C; +14 to +212 °F
Operating pressure ¹⁾	max. 100 bar; 1 450 psi
Outlets	2 to 4
Lubricant	grease: up to NLGI 2 oil at least 12 mm ² /s
Metering quantity	per cycle and outlet
4 outlets:	0,16 cm ³ ; 0,01 in ³
2 outlets	0,32 cm ³ ; 0,02 in ³
Inlet volume flow	max. 45 cm ³ ; 2,75 in ³
Connection inlet/outlet	M12x1 or G1/8
Material	
with M12 x 1:	brass
with G1/8:	steel
with electrical monitoring	cast iron
Electrical monitoring	one electrical cycle/pulse corresponds to 0,64 cm ³ , 0,04 in ³
Electrical connection	plug according to DIN 43650
Voltage rated U _i	30 V DC
Current load I _i	0,02 A
Output function	closer
Switching element	reed contact
Protection class ³⁾	IP 65
Dimensions	55 x 168,5 x 31 mm 2,16 x 6,63 x 1,22 in
Mounting position	any

¹⁾ max. differential pressure with oil 20 bar (290 psi), with grease 30 bar (435 psi)
²⁾ for basic design without electric monitoring
³⁾ available in ATEX design upon request

NOTE

Further technical information, technical drawings, accessories, spare parts or product function descriptions are available on SKF.com/lubrication:

1-3029 EN

Metering devices

SPVS

Order information					
Order number	Outlets	Thread		Monitoring	Material
		G 1/8	M12 x 1	electrical	
44-2578-6321	2	•	–	–	steel
44-2578-6323	4	•	–	–	steel
44-2578-6110	2	–	•	–	brass
44-2578-6201	4	–	•	–	brass
44-2578-6360	2	•	–	•	cast iron
44-2578-6350	4	•	–	•	cast iron

Accessories

Closure plugs SPVS		
Order number	Description	Thread
466-431-001	closure plug	M10x1
466-419-001	closure plug	G1/8

Metering devices

VPB



Description

VPB type metering devices are compact single-block progressive metering. Available with pin indicator for visual system monitoring or with piston detector for electrical system monitoring.

Feature and benefits

- Robust and cost-efficient
- Available in metric and inch design
- Optional visual or electric monitoring
- Internal crossporting possibility, use of standard tube fittings
- Variety of material as zinc coated or stainless steel available

Applications

- Metal forming machines
- Vehicles
- Production machines of automotive industry
- Packaging machines
- Printing industry
- Farm machinery
- Construction and mining

Technical data

Function principle	block metering device
Outlets	6 – 20
Lubricant	grease up to NLGI 2 oil: operating viscosity 12 mm ² /s per stroke and outlet: 0,2 cm ³ ; 0.01 in ³
Metering quantity	
Operating pressure	oil: max. 200 bar; 2 900 psi grease: max. 300 bar; 4 350 psi
Operating temperature	-25 to +110 °C; -13 to +230 °F
Material	stainless steel, tinned/nitrile
Inlet connection	VPBM; M10 × 1 VPBG; G1/8
Outlet connection	VPBM; M10 × 1 VPBG; G1/8
Dimensions	min: 60 × 60 × 30 mm max: 165 × 60 × 30 mm min. 2.36 × 2.36 × 1.18 in min. 6.48 × 2.36 × 1.18 in
Mounting position	
on machines	any
without vibration	piston position should be 90°
on machines with vibration	to machine movements direction



NOTE

Further technical information, technical drawings, accessories, spare parts or product function descriptions available on SKF.com/lubrication:

1-3017-EN, 951-230-008-EN

Metering devices

VPB

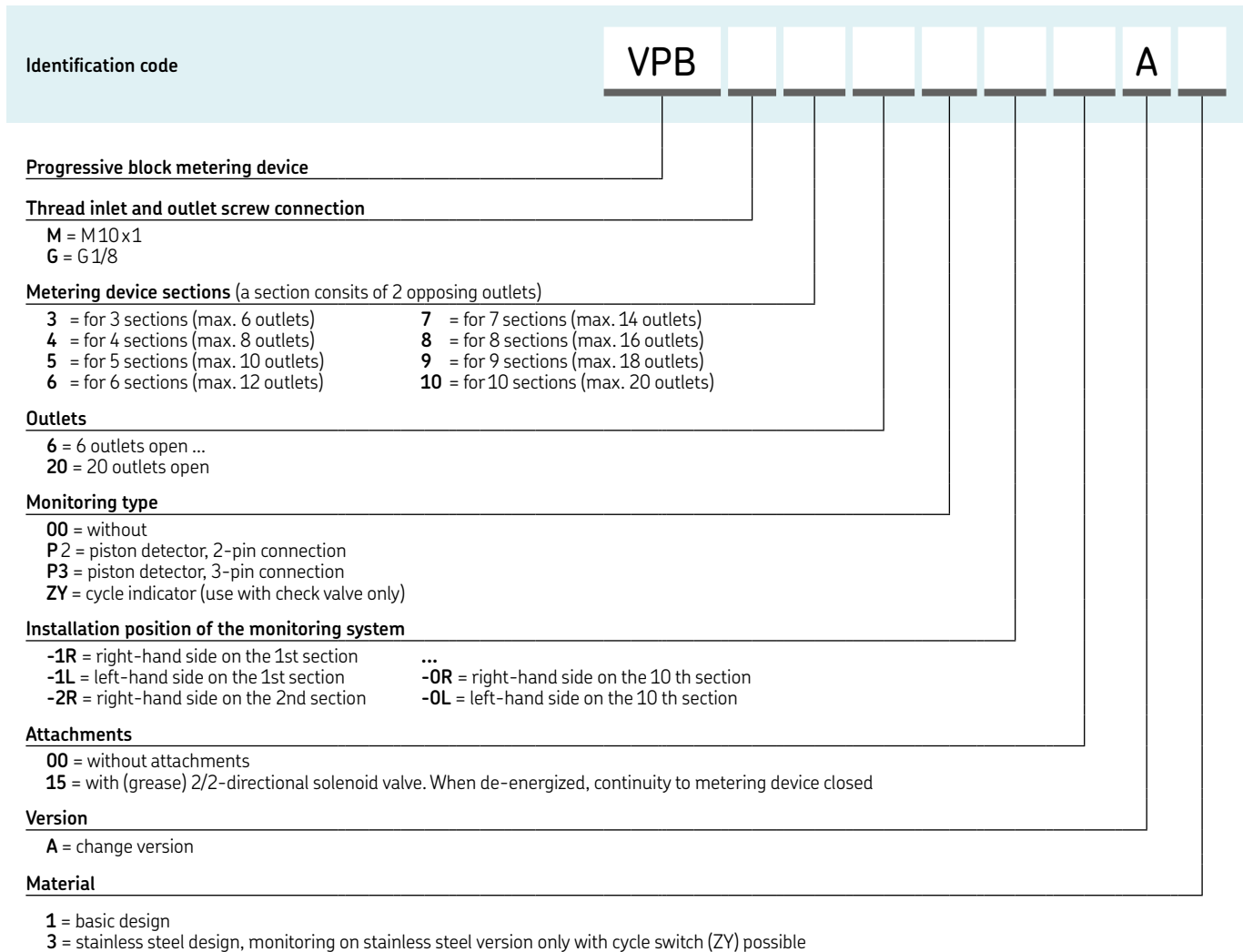

Closure plugs

Order number	Description	Thread
466-431-001	closure plug	M10x1
466-419-001	closure plug	G1/8

Piston detector for VPB (kits with adapter and O-ring)

Order number	Description	Material
24-0159-6023	universal	stainless steel
24-0159-6028	bipolar	stainless steel

Crossporting VPB

Order number	Description	Connections	Thread
		Ø mm	
VPBM-C2	connector	2	M10x1
VPBM-C3	connector	3	M10x1
VPBM-C4	connector	4	M10x1
VPBG-C2	connector	2	G1/8
VPBG-C3	connector	3	G1/8
VPBG-C4	connector	4	G1/8

Check valves for outlets

Order number	Description	Connections	Thread
		Ø mm	
VPKG-RV	screw type	6	R1/8
VPKM-RV-S4	screw type	6	M10x1
VPKG-RV4-VS	push-in type	4	R1/8
VPKG-RV-VS	push-in type	6	G1/8
VPKM-RV-VS	push-in type	6	M10x1
226-10337-3	push-in type	6	M10x1

Metering device

SSV

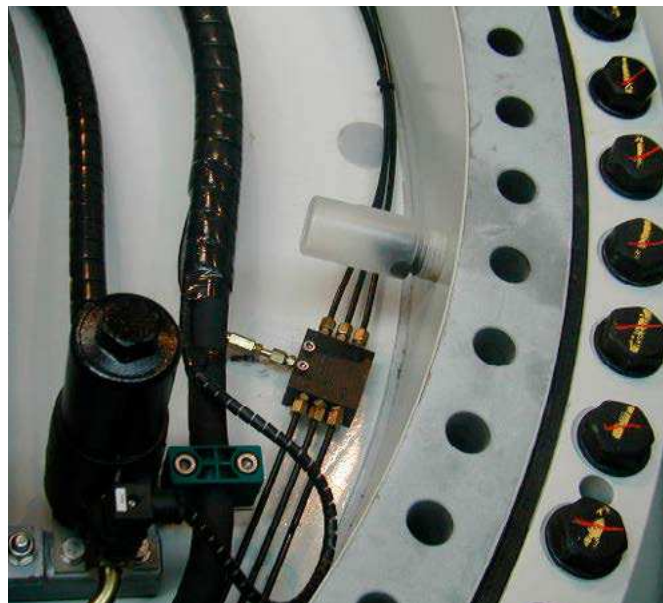

Description

SSV type metering device is a compact single block progressive metering device. For direct mount of fittings with no need of any sealing inbetween. Available with pin indicator for visual system monitoring or with piston detector for electrical system monitoring. Metering device has to be ordered in single parts, see chart.

Features and benefits

- Sizes up to 22 outlets
- High operating pressure
- Available in different materials
- Exact lubricant metering
- Unique internal crossporting technology
- Optionally equipped with visual monitoring pin or with electrically monitored piston detector

Applications

- Construction and mining
- Farm machinery
- Industrial equipment
- Renewable energies

Technical data

Function principle	block metering device
Outlets ¹⁾	6 to 22
Lubricant	
grease:	up to NLGI 2
oil:	at least 40 mm ² /s
Metering quantity	
per cycle and outlet:	0,2cm ³ ; 0.01 in ³
Connection inlet	G 1/8 or R 1/8 NPTF
Connection outlet ²⁾	M 10 x 1
Operating temperature	-40 to +200 °C -40 to +390 °F
Operating pressure	max. 350 bar; 5 075 psi
Material	black chromated steel, stainless steel
Dimensions	min. 60 x 60 x 30 mm max. 180 x 60 x 30 mm min. 2.37 x 2.37 x 1.18 in max. 7.087 x 2.63 x 1.18 in
Mounting position	any

¹⁾ crossporting or closing outlets possible to increase metering quantity of the open outlets - outlet #1 and #2 should never be closed
²⁾ use special SSV outlet fittings

NOTE

Further technical information, technical drawings, accessories, spare parts or product function descriptions are available on SKF.com/lubrication:

12401 EN

Metering device

SSV

Order information

Outlets	Standard	Visual pin	with bypass bore	Piston detector cable (3 m, 9.8 ft) no plug	Indicator pin, proximity switch, cable (2 m, 6.6 ft), no plug	Piston detector, with connection M12, w3 wire
		K	E	N	KN	NP

SSV BSPP black chromated

6	619-26473-1	619-26474-3	619-77345-1	619-28257-1	619-27613-1	619-29050-1
8	619-25730-2	619-25754-4	619-77346-1	619-28258-1	619-27614-1	619-29051-1
10	619-26841-1	619-26842-2	619-77347-1	619-28259-1	619-27615-1	619-29052-1
12	619-25731-2	619-25755-4	619-77348-1	619-28260-1	619-27616-1	619-29674-1
14	619-28862-1	619-28871-1	619-77349-1	619-28890-1	619-29028-1	619-29387-1
16	619-28863-1	619-28872-1	619-77350-1	619-28907-1	619-28905-1	619-29951-1
18	619-28864-1	619-28873-1	619-77351-1	619-28957-1	619-28959-1	619-29139-1
20	619-28865-1	619-28874-1	619-77352-1	619-28935-1	619-28934-1	619-77301-1
22	619-28866-1	619-28875-1	619-77353-1	619-29015-1	619-77461-1	619-29973-1

SSV BSPP, stainless steel 1.4305/303

6	619-27471-1	619-27472-1	619-77680-1	-	-	619-29929-1
8	619-27473-1	619-27474-1	619-77681-1	-	-	619-29322-1
10	619-27475-1	619-27476-1	619-77682-1	-	-	619-29970-1
12	619-27477-1	619-27478-1	619-77683-1	-	-	619-29971-1
14	619-29063-1	619-29067-1	619-77684-1	-	-	619-29993-1
16	619-29064-1	619-29068-1	619-77685-1	-	-	619-29994-1
18	619-29065-1	619-29069-1	619-77686-1	-	-	619-77178-1
20	619-29066-1	619-29074-1	619-77687-1	-	-	-
22	619-29775-1	619-77910-1	619-77688-1	-	-	619-77179-1

SSV BSPP, stainless steel 1.4571/316 Ti

6	619-27824-1	-	-	-	-	-
8	619-27825-1	-	-	-	-	-
10	619-27889-1	-	-	-	-	-
12	619-27900-1	-	-	-	-	-

SSV NPTF, black chromated

6	619-27121-1	619-27122-1	-	-	-	-
8	619-26396-2	619-26646-2	-	-	-	-
10	619-26844-1	619-26845-2	-	-	-	-
12	619-26398-2	619-26648-2	-	-	-	-
14	619-29400-1	619-28899-1	-	-	-	-
16	619-29401-1	619-28900-1	-	-	-	-
18	619-77828-1	619-28901-1	-	-	-	-
20	619-77829-1	619-28902-1	-	-	-	-
22	-	619-77254-1	-	-	-	-

SSV NPTF, stainless steel 1.4305/303

6	619-27792-1	619-27793-1	-	-	-	-
8	619-27796-1	619-27797-1	-	-	-	-
10	619-27800-1	619-27801-1	-	-	-	-
12	619-27804-1	619-27805-1	-	-	-	-
14	-	619-77101-1	-	-	-	-

SSV BSPP, nickel-plated

6	619-78102-1	-	-	-	-	-
8	619-78103-1	-	-	-	-	-
10	619-78104-1	-	-	-	-	-
12	619-78105-1	-	-	-	-	-
14	619-78106-1	-	-	-	-	-
16	619-78114-1	-	-	-	-	-
18	619-78115-1	-	-	-	-	-
20	619-78116-1	-	-	-	-	-
22	619-78117-1	-	-	-	-	-

Accessories

SSV

Outlet fittings, push-in type; valve body with clamping ring

Order number	Designation	Material	Tube Ø mm	Connection
226-14091-6	RV 6511-4-M10x1-S02	brass, nickel-plated	4	plastic tube
226-14091-4	RVM 6511-6-6M10x1-S01	brass, nickel-plated	6	plastic tube hose stud with groove
226-14091-2	RV 6511-6-M10x1-S01	brass, nickel-plated	6	plastic tube
226-14091-8	WRVM 6521-6-M10x1 valve body 90°	brass, nickel-plated	6	plastic tube hose stud with groove
226-14091-9	WRV 6511-6-M10x1 valve body 90°	brass, nickel-plated	6	plastic tube

226-14091-8



Outlet fittings, screw type

Order number	Description	Material	Tube Ø mm
504-30345-2	check valve assembly	steel, black chromated	4
504-30344-4	check valve assembly	steel, black chromated	6
504-31864-1	check valve assembly	steel, black chromated	8
504-31863-1	check valve assembly	steel, black chromated	8
504-31709-1	check valve assembly	stainless steel, 1.4571	4
504-31705-1	check valve assembly	stainless steel, 1.4571	6

226-14091-4



Outlet closure plug

Order number	Description
303-17499-3	outlet closure plug with sealing edge, steel
303-19346-2	outlet closure plug with sealing edge, stainless steel
219-13798-3	O-ring for stainless steel closure plug; if after tightening with 18 Nm not sealed

303-17499-3



Outlet combining element

Order number	Description	Material	Tube Ø mm
519-31826-1	external outlet combining element for outlets 1 and 2	steel, black chromated	6

519-31826-1



Accessories

SSV

Universal piston detector

Order number	Description
234-13163-9	universal piston detector 10-35 VDC
234-11454-1	bipolar piston detector
419-74031-1	adapter SSV/SSVD
237-13442-4	plug
237-13442-6	90° plug with cable 5 m (16.5 ft)
236-10022-7	straight plug with cable 10 m (33 ft)

Piston detector with cable

Order number	Description
664-85282-7	piston detector with cable; 3 m (10 ft)
664-85282-6	piston detector stainless steel with cable; 3 m (10 ft)
664-85282-8	piston detector with cable; 5 m (16.5 ft)

Piston detector with cable and bayonet plug

Order number	Description
664-85242-2	piston detector with cable; 3 m (10 ft); bayonet plug
664-85242-5	piston detector with cable; 7 m (23 ft); bayonet plug

Pressure indicating units for SSV

Order number	Description	Pressure	
		bar	psi
532-60073-1	pressure indicator assembly	50	725
532-60075-1	pressure indicator assembly	200	2 900
532-60085-1	pressure indicator assembly	270	3 915

Accessories for proximity switch KS

Order number	Description
519-36713-7	limit switch with accessories
236-13281-2	limit switch V3S+VL1

Accessories for proximity switch KN

Order number	Description
234-10812-8	proximity switch PNP, 10-30 VDC,
234-13134-5	proximity switch NPN, 10-30 VDC
519-30911-1	adapter with stop ring

Pressure checking set

Order number	Description
604-36879-1	set for checking pressure and function

Special screwdriver

Order number	Description
404-22614-1	special screwdriver for closure plugs on SSV metering devices

Bracket SSV

Order number	Description	Material
307-19543-1	bracket for SSV	steel, galvanized
519-34271-1	bracket for SSV 14 ... SV 22	steel, galvanized

307-19543-1



519-34271-1



Metering device

SSVL



Description

SSVL type metering device is a single block progressive metering device with larger tube diameters especially for heavy industry applications. Available with pin indicator for visual system monitoring or with piston detector for electrical system monitoring. Outlet combining elements for 2, 3, 4 and 5 outlets available.

Features and benefits

- Similar to SSV but with larger distances between the outlets for larger tube diameters
- Sizes 6 to 14 outlets
- High operating pressure
- Exact lubricant metering
- Optionally equipped with visual monitoring pin or with electrically monitored piston detector

Applications

- Heavy industry
- Construction machinery
- Vehicles

Technical data

Function principle	block metering device
Operating temperature	-25 to +75 °C; -13 to +167 °F
Operating pressure	max. 350 bar; 5 075 psi
Outlets ¹⁾	6 to 14
Lubricant	
grease:	up to NLGI 2
oil:	at least 40 mm ² /s
Metering quantity	per cycle and outlet: 0,2 cm ³ ; 0.12 in ³
Connection inlet	R 1/4
Connection outlet	8, 10 oR 12 mm
Material	black chromated steel
Dimensions	min. 90 × 60 × 40 mm max. 210 × 60 × 40 mm min. 3.54 × 2.36 × 1.57 in max. 8.26 × 2.36 × 1.57 in
Mounting position	any

¹⁾ To ensure metering device operation outlet 1 and 2 should never be closed by a closure plug

NOTE

Further technical information, technical drawings, accessories, spare parts or product function descriptions are available on SKF.com/lubrication.

Metering device

SSVL

SSVDL			
Outlets	Order number Standard	Visual pin	with bypass bore
6	649-77167-1	649-77474-1	649-77464-1
8	649-77168-1	649-77475-1	649-77466-1
10	649-77169-1	649-77476-1	649-77468-1
12	649-77170-1	649-77477-1	649-77470-1
14	649-77171-1	649-77478-1	649-77472-1

Accessories

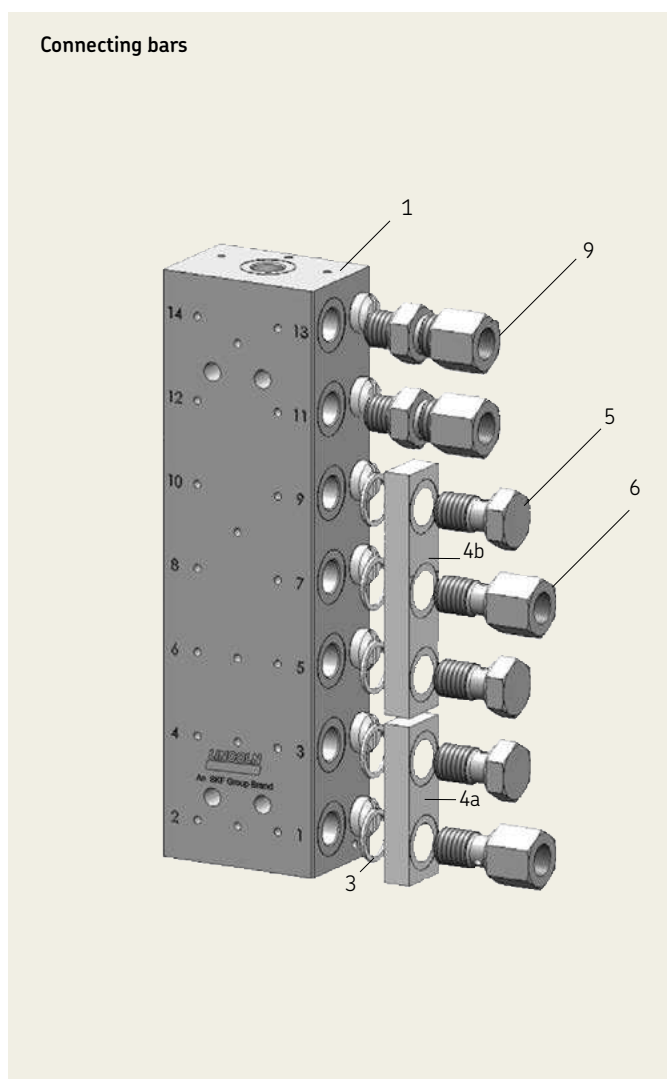

Connecting bars (item 4)

Order number	Description
519-34643-1	double, assembly (incl. pos. 2 × 3, 1 × 5)
519-34643-2	triple, assembly (incl. pos. 3 × 3, 2 × 5)
519-34643-3	quadruple, assembly (incl. pos. 4 × 3, 3 × 5)
519-34643-4	quintuple, assembly (incl. pos. 5 × 3, 4 × 5)

Accessories for combining outlets (item 6)

Order number	Description	Tube Ø mm
504-33659-1	check valve	8
504-33660-1	check valve	10
504-33661-1	check valve	12

Outlet tube fittings with check valve (item 9)

Order number	Designation	Tube Ø mm
223-13052-2	GERV 8 LR 1/4 V	8
223-13052-3	GERV 10 LR 1/4 V	10
223-13052-5	GERV 12 LR 1/4 V	12

Metering device

VPK



Description

The VPK type metering device is a sectional metering device. Its metering sections cover a metering volume per outlet and cycle of 0,05 cm³ (T-section = 2 outlets) to 0,6 cm³ (S-section = 1 outlet). All sections (inlet, intermediate, end) are tightened via tie rods. The delivery ducts are sealed by porting plates in-between the segments. A minimum of three intermediate sections is necessary.

Features and benefits

- Volumetric flow of up to 500 cm³/min; 30.5 in³/min
- Universal use in continuous or intermittent operation
- Metering sections with variable metering amount
- Internal consolidation of outlets
- Visual or electrical monitoring optional
- Safe sealing concept with porting plates

Applications

- Metal forming machines
- Vehicles
- Production machines of automotive industry
- Packaging machines
- Printing industry
- Construction and mining
- Farm machinery

Technical data

Function principle	sectional metering device
Operating temperature	-25 to +90 °C; -13 to 194 °F
Operating pressure	oil: 200 bar; 2 900 psi grease: 300 bar; 4 350 psi
Outlets	6 to 20
Lubricant	
grease	up to NLGI 2;
oil	viscosity min. 12 mm ² /s
Metering quantity	per cycle and outlet: 0,05–0,6 cm ³ ; 0.003–0.037 in ³
Material:	
inlet, separator and end plate	steel, galvanized/NBR
sections/piston plate	steel, galvanized
Connection inlet	VPKM/VPKG: M10 × 1/G 1/8
Connection outlet	VPKM/VPKG: M10 × 1/G 1/8
Dimensions	min. 81,9 × 65 × 34 mm max. 195,3 × 65 × 34 mm min. 3.22 × 2.56 × 1.34 in max. 7.69 × 2.56 × 1.34 in
Mounting position:	
on machines without vibration	any
on machines with vibration	piston position should 90° to machine's movement direction

NOTE

Further technical information, technical drawings, accessories, spare parts or product function descriptions available on SKF.com/lubrication:
1-3015-EN, 951-230-008-EN

CAD: skf-lubrication.partcommunity.com

VPK

Exploded view

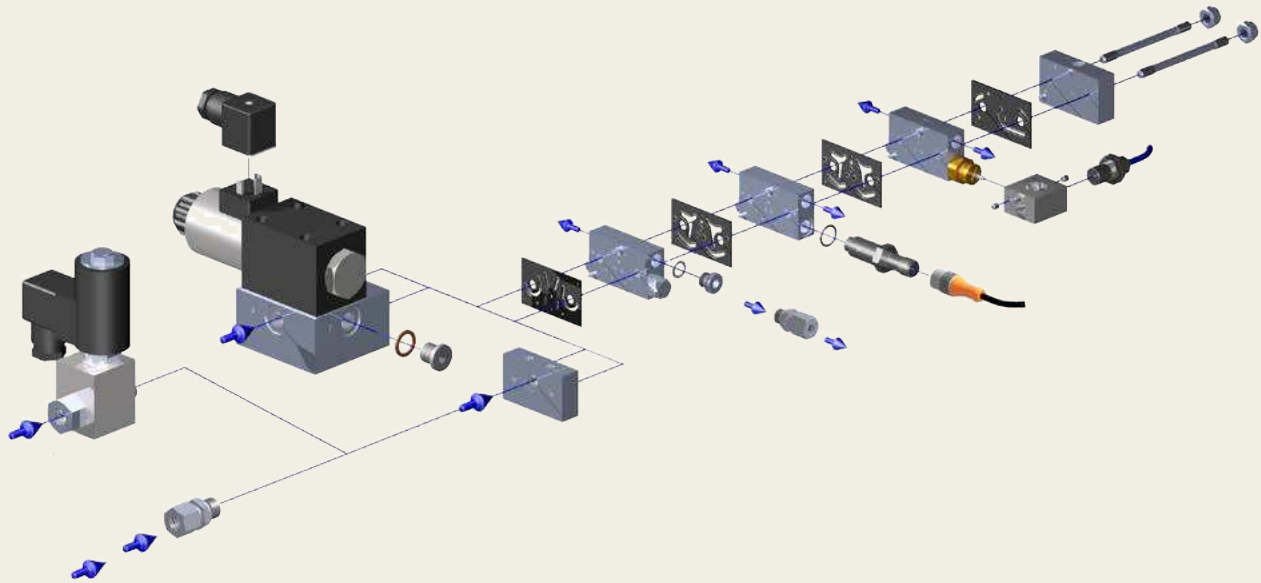

Inlet fittings

Description	Tube Ø mm	Order number VPKG	Order number VPKM
straight connector, L ¹⁾	6	223-13016-3	223-10263-8
straight connector, tapered LL ¹⁾	6	-	223-13021-1
straight connector, tapered LL ¹⁾	8	223-12270-9	441-008-511
straight connector, tapered L	10	410-443W	-
straight connector, type E fitting acc. DIN EN ISO 9974-3	6	471-06-192	471-006-311
straight quick connector	6	406-423W-VS	406-004-VS
straight quick connector, tapered	6	406-423W	451-006-518-VS
elbow, tapered, L ¹⁾	6	223-13048-1	223-12485-8
elbow, tapered, LL ¹⁾	6	-	223-13021-3
elbow, tapered, LL ¹⁾	8	408-425W	223-12362-4
elbow quick connector, tapered	6	506-511-VS	506-510-VS
banjo fitting, L ¹⁾	6	223-12479-5	445-531-061
banjo fitting, LL ¹⁾	6	-	445-531-062
quick connector- banjo fitting	6	506-108-VS	506-140-VS
quick connector- banjo fitting, tapered	6	-	455-431-068-VS

¹⁾ Solderless pipe unions with cutting sleeve acc. to DIN 2353
LL-series = extra-light version, L-series = light version

Accessories

VPK

Outlet fittings

Description	Tube Ø mm	Order number VPKG	Order number VPKM
straight connector, tapered, LL ¹⁾	4	–	223-13069-1
straight connector, LL ¹⁾	4	223-12270-8	–
straight connector, tapered, LL ¹⁾	6	–	223-13021-1
straight connector, L ¹⁾	6	223-13016-3	223-10263-8
straight connector, tapered, LL ¹⁾	8	223-12270-9	441-008-511
straight connector, tapered, L ¹⁾	10	410-443W	–
straight connector, type E fitting acc. DIN EN ISO 9974-3	4	471-004-191	471-004-311
straight connector, type E fitting acc. DIN EN ISO 9974-3	6	471-006-192	471-006-311
straight quick connector	4	404-040-VS	404-006-VS
straight quick connector, tapered	4	–	451-004-518-VS
straight quick connector	6	456-004-VS	406-004-VS
straight quick connector, tapered	6	406-423W-VS	451-006-518-VS
outlet screw union, with CV	6	VPKG-RV	VPKM-RV-S4
quick connector, with CV	6	–	VPKM-RV-VS
banjo fitting, LL	4	445-519-041	–
banjo fitting, L	6	223-12479-5	445-531-061
banjo fitting, LL	6	–	445-531-062
quick connector-banjo fitting	4	504-108-VS	504-102-VS
quick connector-banjo fitting, tapered	4	–	455-531-048-VS
quick connector-banjo fitting	6	506-108-VS	506-140-VS
quick connector-banjo fitting, tapered	6	–	445-431-068-VS

¹⁾ Solderless pipe unions with cutting sleeve acc. to DIN 2353
LL-series = extra-light version, L-series = light version, CV = check valve

Universal and bipolar piston detector

The universal and bipolar piston detectors are position sensors that are screwed into the metering device together with the relevant pressure-resistant adapter. The sensors detect the piston by means of the closed adapter without coming into direct contact with it. They adjust themselves independently after several distribution strokes. Therefore, hydraulic pressure peaks do not act directly on the frontal sensor surface of the piston detectors.

Kit, with piston detector, O-ring and adapter

Order number	Description	Material
24-0159-6022	bipolar	stainless steel
24-0159-6024	universal	stainless steel

Metering device

VP



Description

The VP type metering device is a sectional metering device. Its metering sections cover a metering volume per outlet and cycle of 0,1 cm³ (T-section = 2 outlets) to 1,2 cm³ (S-section = 1 outlet). All sections (inlet, intermediate, end) are tightened via tie rods. The delivery ducts are sealed by porting plates in between the segments. A minimum of three intermediate sections is necessary.

Features and benefits

- Volumetric flow of up to 1,0 l/min; 61 in³/min
- Universal use in continuous or intermittent operation
- Metering sections with variable metering amount
- Internal and external consolidation of outlets
- Visual or electrical monitoring optional
- Ideal as main metering device
- All outlets with built-in, non-return valves

Applications

- Preferred master metering device
- Metal forming machines
- Vehicles, trucks
- Construction and mining
- Packaging machines
- General industry
- Farm machinery

Technical data

Function principle	sectional metering device
Outlets	6 to 20
Lubricant	up to NLGI 2;
grease	environmentally friendly mineral and synthetic oils; viscosity min. 12 mm ² /s
Metering quantity	per cycle and outlet: 0,1–1,2 cm ³ ; 0,006–0,073 in ³
Flow rate	1 l/min; 61 in ³ /min
Operating temperature	–25 to +90 °C; –13 to 194 °F
Operating pressure	oil: 200 bar; 2 900 psi grease: 300 bar; 4 350 psi
Material:	
inlet, separator and end plate	steel, galvanized/NBR
sections/piston plate	steel, galvanized
Connection inlet	VPM/VPG; M14 × 1,5/G 1/4
Connection outlet	VPM/VPG; M10 × 1/G 1/8
Protection class	IP 67
Dimensions	min. 98 × 82,5 × 41 mm max. 238 × 82,5 × 41 mm min. 3.86 × 3.25 × 1.61 in max. 9.37 × 3.25 × 1.61 in
Mounting position:	
on machines without vibration	any
on machines with vibration	piston position should 90° to machine's movement direction



NOTE

Further technical information, technical drawings, accessories, spare parts or product function descriptions available on SKF.com/lubrication:

15400EN, 951-230-008 EN



CAD: skf-lubrication.partcommunity.com

Exploded view

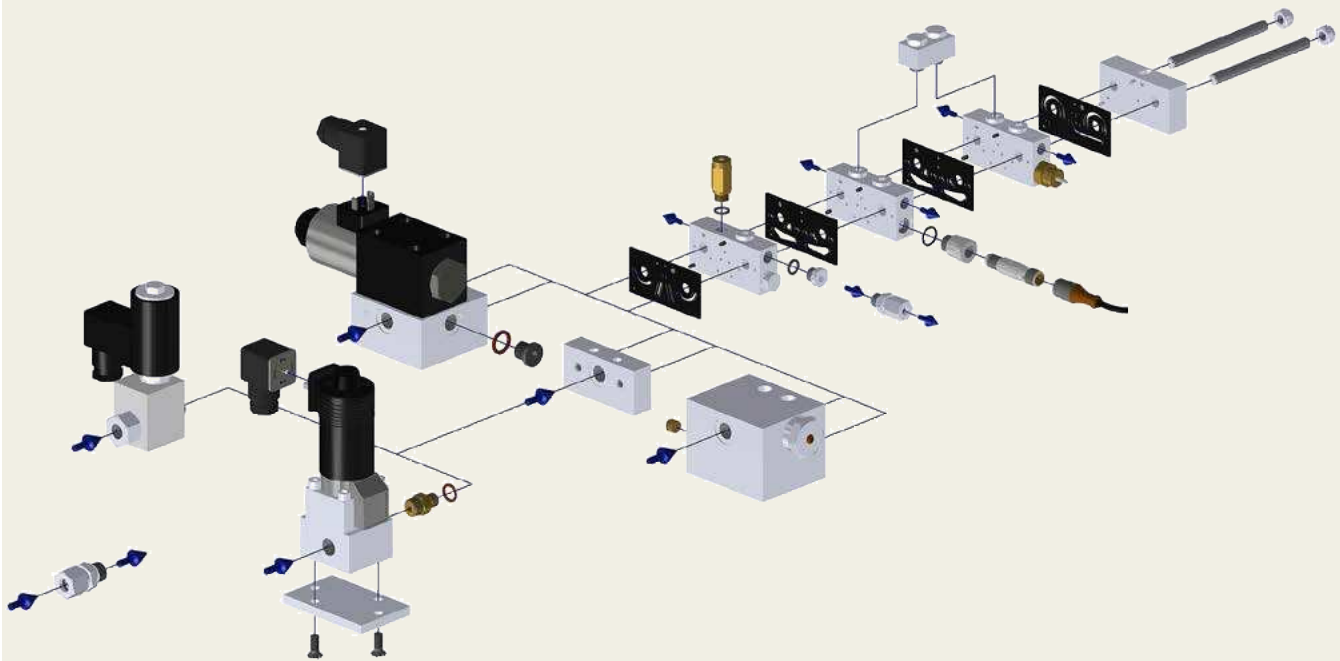

Inlet fittings

Description	Tube Ø mm	Order number VPG	Order number VPM
straight connector, L ¹⁾	6	-	223-14129-4
straight connector, S ¹⁾	6	406-413W	-
straight connector, L ¹⁾	8	223-12477-6	-
straight connector, S ¹⁾	8	-	408-413
straight connector, L ¹⁾	10	223-12272-9	223-14129-4
straight connector, L ¹⁾	12	223-12477-9	412-423
straight connector, type E fitting acc. DIN EN ISO 9974-3	6	471-006-161	471-006-351
straight connector, type E fitting acc. DIN EN ISO 9974-3	8	471-008-161	471-008-351
straight connector, type E fitting acc. DIN EN ISO 9974-3	10	471-010-161	471-010-351
straight connector, type E fitting acc. DIN EN ISO 9974-3	12	471-012-161	-
straight quick connector	6	406-054-VS	-
elbow, tapered, L ¹⁾	8	223-14240-5	-
elbow, tapered, L ¹⁾	10	223-13048-5	410-405
banjo fitting, S ¹⁾	6	445-516-061	-
banjo fitting, L ¹⁾	8	223-12284-7	-
banjo fitting, L ¹⁾	10	223-12369-9	445-535-101

¹⁾ Solderless pipe unions with cutting sleeve acc. to DIN 2353
L-series = light version, S-series = heavy version

Accessories

VP

Outlet fittings

Description	Tube Ø mm	Order number VPG	Order number VPM
straight connector, tapered, LL ¹⁾	4	–	223-13069-1
straight connector, LL ¹⁾	4	223-12270-8	–
straight connector, tapered, LL ¹⁾	6	–	223-13021-1
straight connector, L ¹⁾	6	223-13016-3	223-10263-8
straight connector, tapered, LL ¹⁾	8	223-12270-9	441-008-511
straight connector, tapered, L ¹⁾	10	410-443W	–
straight connector, type E fitting acc. DIN EN ISO 9974-3	4	471-004-191	471-004-311
straight connector, type E fitting acc. DIN EN ISO 9974-3	6	471-006-192	471-006-311
straight quick connector	4	404-040-VS	404-006-VS
straight quick connector, tapered	4	–	451-004-518-VS
straight quick connector	6	456-004-VS	406-004-VS
straight quick connector, tapered	6	406-423W-VS	451-006-518-VS
outlet fitting, with CV	4	VPG-RV	VPM-RV4
outlet fitting, with CV	6	VPG-RV6	VPM-RV
outlet fitting, with CV	8	VPG-RV8	VPM-RV8
outlet fitting, with CV	10	–	VPM-RV10
banjo fitting, LL	4	445-519-041	–
banjo fitting, L	6	223-12479-5	445-531-061
banjo fitting, LL	6	–	445-531-062
quick connector-banjo fitting	4	504-108-VS	504-102-VS
quick connector-banjo fitting, tapered	4	–	455-531-048-VS
quick connector-banjo fitting	6	506-108-VS	506-140-VS
quick connector-banjo fitting, tapered	6	–	445-431-068-VS

¹⁾ Solderless pipe unions with cutting sleeve acc. to DIN 2353
LL-series = extra-light version, L-series = light version, CV = check valve

Crossporting bars

Crossporting bars are used to combine adjacent outlet ports. They are screwed into the lateral outlet ports or, if on hand, into the upper alternative outlet ports.

Crossporting bars

Order number	Description
VP-C	VPM crossporting bridge for 2 outlets
VPG-C	VPG crossporting bridge for 2 outlets

Universal and bipolar piston detector

The universal and bipolar piston detectors are position sensors that are screwed into the metering device together with the relevant pressure-resistant adapter. The sensors detect the piston by means of the closed adapter without coming into direct contact with it. They adjust themselves independently after several distribution strokes. Therefore, hydraulic pressure peaks do not act directly on the frontal sensor surface of the piston detectors.

Kit, with piston detector, O-ring and adapter

Order number	Description	Material
24-0159-6022	bipolar	stainless steel
24-0159-6024	universal	stainless steel

Metering device

PSG1

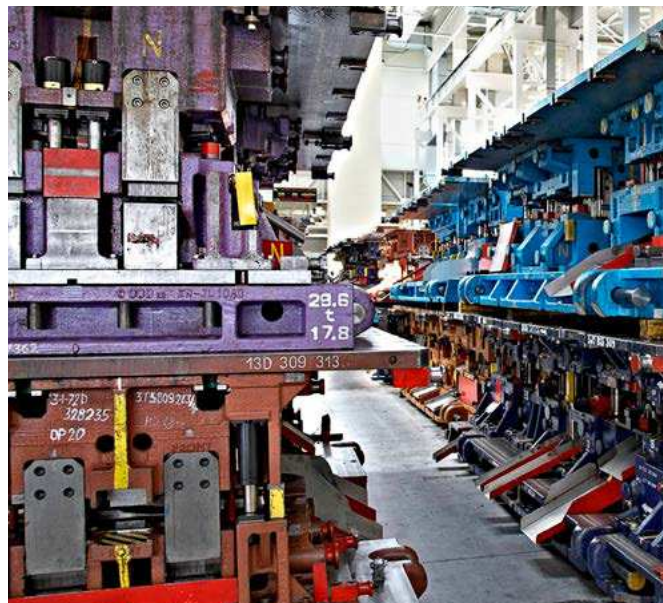

Description

The PSG1 is a progressive metering device consisting of a baseplate and different metering sections that can be individually combined for specific outlet ratios and cross portings. The ports are part of the baseplate, so that connectors and tubes remain in place when segments need to be changed.

Features and benefits

- Easy servicing as outlets are located on baseplate
- Flexible due to exchangeable metering segments
- Visual or electrical monitoring possible
- Dummy segments with no output available
- Adjustable by consolidating outlets internally or externally

Applications

- Automobile presses
- Paper machines
- Tunnel boring machines

PSG1 accessories

Order number	Description
466-419-001	closure plug for baseplate outlet incl. washer
24-2151-3760	crossporting bridge, 2 outlets ¹⁾
24-2151-3762	crossporting bridge, 2 outlets, with outlet port ¹⁾
24-2151-3764	crossporting bridge, 2 outlets, with outlet port and check valve ¹⁾
24-0159-6024	universal piston detector with O-ring and adapter, stainless steel

¹⁾ bridges are approved for a maximum operating pressure of 100 bar; crossporting bridge also available for 3 outlets, see brochure

Technical data

Function principle	segmented metering device
Outlets	6 to 20
Lubricant	grease: up to NLGI 2 oil: min. viscosity 12 mm ² /s per cycle and outlet:
Metering quantity	min. 0,05 cm ³ ; 0.003 in ³ max. 0,25 cm ³ ; 0.015 in ³ max. 0,8 l/min; 0.17 pts/min
Flow rate	
Operating temperature	-15 to +110 °C; +5 to 230 °F
Operating pressure ¹⁾	200 bar; 2 900 psi
Material	
baseplate:	aluminum alloy
sections:	steel galvanized
Connection inlet	G ¹ / ₈
Connection outlet	G ¹ / ₄
Protection class	IP 67
Dimensions	min. 90 × 55 × 41 mm max. 244 × 55 × 41 mm min. 3.54 × 2.17 × 1.61 in max. 9.61 × 2.17 × 1.61 in
Mounting position:	
on machines without vibration	any
on machines with vibration	piston position should be 90° to machine's movement direction

¹⁾ Operating pressure may be lower depending on design with monitoring or attachments

NOTE

Further technical information, technical drawings, accessories, spare parts or product function descriptions available on SKF.com/lubrication:

1-3010 EN; 951-230-013

CAD: skf-lubrication.partcommunity.com

Metering device

PSG1

Identification code	PSG1	X	X	X					
Product series									
Monitoring									
X = none 3 = 3-pin piston detector, M12x1 plug Y = cycle indicator, visual plunger rod ^{1) 2)} S = cycle indicator with bracket and proximity switch ^{1) 2)} G = cycle indicator with bracket for proximity switch (without proximity switch) ^{1) 2)}									
Position of monitoring device ²⁾									
X = none A = left, section 1 C = left, section 2 E = left, section 3 G = left, section 4 J = left, section 5 L = left, section 6 N = left, section 7 Q = left, section 8 S = left, section 9 U = left, section 10 B = right, section 1 D = right, section 2 F = right, section 3 H = right, section 4 K = right, section 5 M = right, section 6 P = right, section 7 R = right, section 8 T = right, section 9 V = right, section 10									
Connector baseplate inlet³⁾									
X = none A = tube Ø 6 mm					B = tube Ø 8 mm C = tube Ø 10 mm				
Sections									

... = to be configured in the section configurator below

Section configurator	— —
Section (minimum 3 sections) ⁴⁾	
X = dummy section A = 0,05 cm ³ /cycle ⁵⁾ C = 0,15 cm ³ /cycle B = 0,10 cm ³ /cycle D = 0,20 cm ³ /cycle E = 0,25 cm ³ /cycle	
Outlet connector left	
S = outlet closed by screw plug ⁶⁾ X = outlet without fitting	
Outlet connector right	
S = outlet closed by screw plug ⁶⁾ X = outlet without fitting	

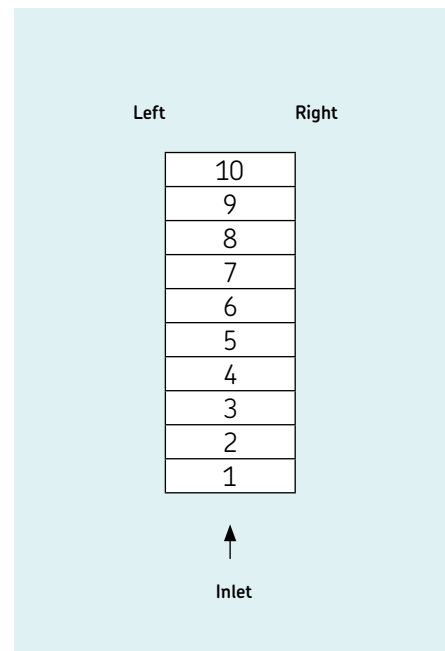

¹⁾ Only on 200 and 250 mm³ section sizes
²⁾ Installation on first or last section is not recommended
³⁾ Solderless pipe union with cutting sleeve per DIN 2353
⁴⁾ The volume per section is equal on both sides
⁵⁾ If possible, do not place in first position when designing metering device
⁶⁾ Metering device only operates with one side (left or right) outlet closed per section

Metering device

PSG2

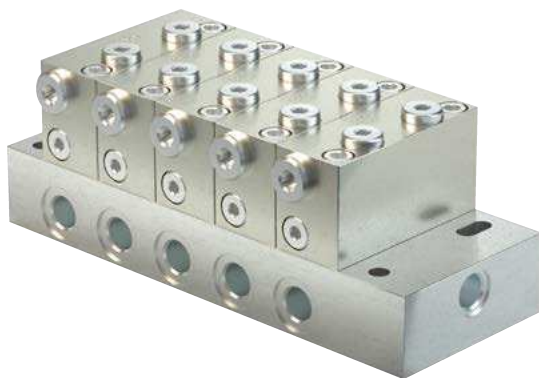

Description

The PSG2 is a progressive metering device consisting of a baseplate and different metering sections that can be individually combined for specific outlet ratios and cross portings. The ports are part of the baseplate, so that connectors and tubes remain in place when segments need to be changed.

Features and benefits

- Easy servicing due to outlet location
- Flexible with exchangeable metering segments
- Visual or electrical monitoring available
- Increased corrosion-resistant material offered
- Adjustable output by consolidating outlets internally or externally

Applications

- Automobile presses
- Tunnel boring machines
- Paper machines

Technical data

Function principle	segmented metering device
Operating temperature	-15 to +110 °C; +5 to +230 °F
Operating pressure ¹⁾	200 bar; 2 900 psi
Outlets	6 to 20
Lubricant	grease: up to NLGI 2 oil: min. viscosity of 12 mm ² /s
Metering quantity	per cycle and outlet: min. 0,06 cm ³ ; 0.0037 in ³ max. 0,84 cm ³ ; 0.051 in ³ max. 2,5 l/min; 5.3 pts/min
Flow rate	
Material	
baseplate:	aluminium alloy or anodized
sections:	steel or nickel plated
Connection inlet	G 3/4
Connection outlet	G 1/4
Protection class	IP67
Dimensions	min. 131 × 86 × 71 mm max. 327 × 86 × 71 mm min. 5.16 × 3.39 × 2.80 in max. 12.87 × 3.39 × 2.80 in
Mounting position:	
on machines without vibration	any
on machines with vibration	piston position should be 90° to machine movement direction
Options	flow limiter

¹⁾ Operating pressure may be lower depending on design with monitoring or attachments

PSG2 accessories

Order number	Description
466-419-001	closure plug for baseplate outlet incl. washer
24-2151-3760	crossporting bridge, 2 outlets ¹⁾
24-2151-3762	crossporting bridge, 2 outlets, with outlet port ¹⁾
24-2151-3764	crossporting bridge, 2 outlets, with outlet port and check valve ¹⁾
24-0159-6024	universal piston detector with O-ring and adapter

¹⁾ Bridges are approved for a maximum operating pressure of 100 bar; crossporting bridge also available for 3 outlets, see brochure



NOTE

Further technical information, technical drawings, accessories, spare parts or product function descriptions available on SKF.com/lubrication:

1-3010 EN; 951-230-01



CAD: skf-lubrication.partcommunity.com

Metering device

PSG2

Identification code	PSG2						X	X	X	
Product series										
Monitoring	<p>X = none 3 = 3-pin piston detector, M12x1 plug Y = cycle indicator, visual plunger rod ^{1) 2)} S = cycle indicator with bracket and proximity switch ^{1) 2)} G = cycle indicator with bracket for proximity switch (without proximity switch) ^{1) 2)}</p>									
Position of monitoring device ²⁾	<p>X = none A = left, section 1 B = right, section 1 C = left, section 2 D = right, section 2 E = left, section 3 F = right, section 3 G = left, section 4 H = right, section 4 J = left, section 5 K = right, section 5 L = left, section 6 M = right, section 6 N = left, section 7 P = right, section 7 Q = left, section 8 R = right, section 8 S = left, section 9 T = right, section 9 U = left, section 10 V = right, section 10</p>									
Connector baseplate inlet ³⁾	<p>X = none A = tube Ø 6 mm B = tube Ø 8 mm C = tube Ø 10 mm D = tube Ø 12 mm</p>									
Sections	<p>... = to be configured in the section configurator below</p>									

Section configurator ⁴⁾	<div style="border: 1px solid black; width: 100px; height: 20px; margin: 0 auto;"></div>	
Section (minimum 3 sections) ⁴⁾	<p>x = dummy section F = 0,06 cm³/cycle ⁵⁾ K = 0,48 cm³/cycle G = 0,12 cm³/cycle L = 0,60 cm³/cycle H = 0,24 cm³/cycle M = 0,72 cm³/cycle J = 0,36 cm³/cycle N = 0,84 cm³/cycle</p>	
Outlet connector left	<p>S = outlet closed by screw plug ⁶⁾ X = outlet without connector</p>	
Outlet connector right	<p>S = outlet closed by screw plug ⁶⁾ X = outlet without connector</p>	

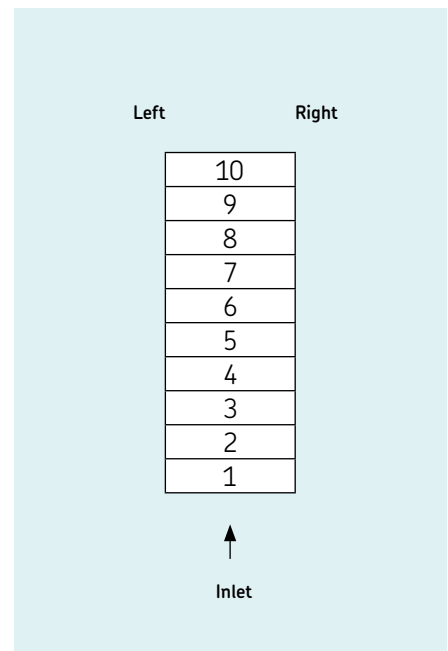

1) Only on 60 mm² section sizes
 2) Installation on first or last section is not recommended
 3) Solderless pipe union with cutting sleeve per DIN 2353
 4) The volume per section is equal on both sides
 5) If possible, do not place in first position when designing metering device
 6) Metering device only operates with one side (left or right) outlet closed per section

Metering device

PSG3

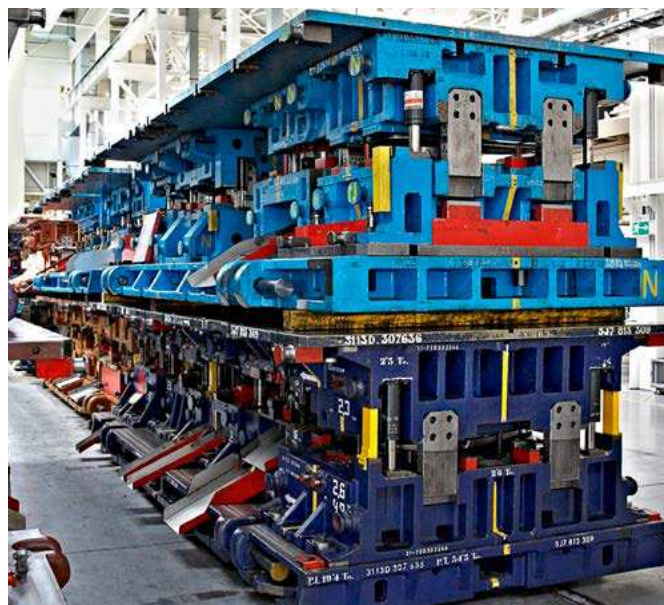
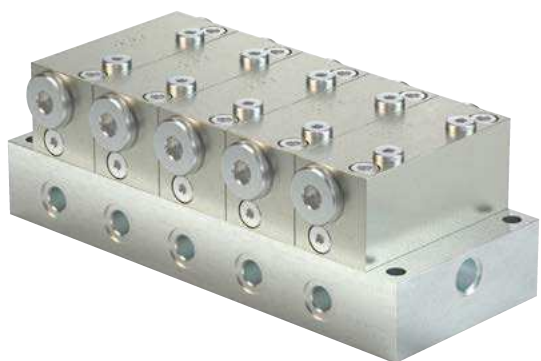

Description

The PSG3 is a progressive metering device consisting of a baseplate and different metering sections that can be individually combined for specific outlet ratios and cross portings. The ports are part of the baseplate, so that connectors and tubes remain in place when segments need to be changed.

Features and benefits

- Easy servicing as outlets are located on baseplate
- Flexible with exchangeable metering segments
- Visual or electrical monitoring available
- Increased corrosion-resistant material available
- Dummy segments without output available
- Adjustable output by consolidating outlets internally or externally
- Main metering device in circulating oil systems

Applications

- Automobile presses
- Paper machines
- Tunnel boring machines

Technical data

Function principle	segmented metering device
Operating temperature	-15 to +110 °C; +5 to +230 °F
Operating pressure ¹⁾	200 bar 2 900 psi
Outlets	6 to 20
Lubricant	grease up to NLGI 2 oil: min. viscosity 12 mm ² /s
Metering quantity	per cycle and outlet: min. 0,80 cm ³ ; 0.049 in ³ max. 3,20 cm ³ ; 0.195 in ³ max. 6 l/min; 12.7 pts/min
Flow rate	
Material baseplate:	aluminium alloy or anodized
sections:	steel galvanized or nickel plated
Connection inlet	G 3/8
Connection outlet	G 1/4
Protection class	IP 67
Dimensions	min. 165 × 108 × 88 mm max. 466 × 108 × 88 mm min. 6.50 × 4.25 × 3.46 in max. 18.35 × 4.25 × 3.46 in
Mounting position:	
on machines without vibration	any
on machines with vibration	piston position should be 90° to machine's movement direction
Options	flow limiter

¹⁾ Operating pressure may be lower depending on design with monitoring or attachments

PSG3 accessories

Order number	Description
DIN908-R 1-4-5.8	closure plug for baseplate outlet
508-108	washer for closure plug
24-2151-3734	crossporting bridge, 2 outlets ¹⁾
24-2151-3736	crossporting bridge, 2 outlets with outlet ports ¹⁾
24-0159-6024	universal piston detector with O-ring and adapter

¹⁾ bridges are approved for a maximum operating pressure of 100 bar; crossporting bridge also available for 3 outlets, see brochure

NOTE

Further technical information, technical drawings, accessories, spare parts or product function descriptions available on SKF.com/lubrication:
1-3010 EN; 951-230-013

CAD: skf-lubrication.partcommunity.com

Metering device

PSG3

Identification code	PSG3	X	X	X						
Product series										
Monitoring	<p>X = none 3 = 3-pin piston detector, M12x1 plug Y = cycle indicator, visual plunger rod ¹⁾ S = cycle indicator with bracket and proximity switch ¹⁾ G = cycle indicator with bracket for proximity switch (without proximity switch) ¹⁾</p>									
Position of monitoring device ²⁾	<p>X = none A = left, section 1 B = right, section 1 C = left, section 2 D = right, section 2 E = left, section 3 F = right, section 3 G = left, section 4 H = right, section 4 J = left, section 5 K = right, section 5 L = left, section 6 M = right, section 6 N = left, section 7 P = right, section 7 Q = left, section 8 R = right, section 8 S = left, section 9 T = right, section 9 U = left, section 10 V = right, section 10</p>									
Connector baseplate inlet ²⁾	<p>X = none D = tube Ø12 mm B = tube Ø8 mm E = tube Ø15 mm C = tube Ø10 mm F = tube Ø16 mm</p>									
Sections	<p>... = to be configured in the section configurator below</p>									

Section configurator	-	-
Section (minimum 3 sections) ³⁾	<p>X = dummy section R = 1,60 cm³/cycle P = 0,80 cm³/cycle ⁴⁾ S = 2,40 cm³/cycle Q = 1,20 cm³/cycle T = 3,20 cm³/cycle</p>	
Outlet fitting left	<p>S = outlet closed by screw plug ⁵⁾ X = outlet without fitting</p>	
Outlet fitting right	<p>S = outlet closed by screw plug ⁵⁾ X = outlet without fitting</p>	

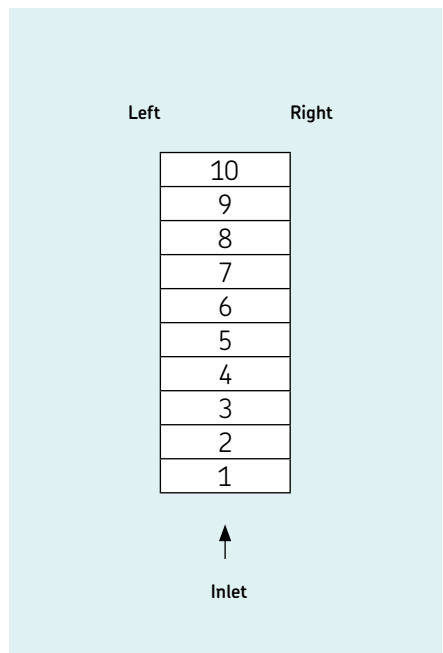

¹⁾ Installation on first or last section is not recommended
²⁾ Solderless pipe union with cutting sleeve per DIN 2353
³⁾ The volume per section is equal on both sides
⁴⁾ If possible, do not place in first position when designing metering device
⁵⁾ Metering device only operates with one side (left or right) outlet closed per section

Metering device

UV



Description

UV metering devices are modular type metering devices. They consist of a baseplate part and a metering sections part. The baseplate has one inlet, three to eight intermediate, one end section held via three tie rods. The metering sections part consists of three to eight metering sections (depending on number of outlets needed) which are fixed on the baseplate part. All parts have FKM O-ring seals in-between. There must be a minimum of three metering sections. The metering sections will have either single or twin outlets. Whenever a single metering segment or crossport plate is used, the unused outlet must be plugged. Metering device has to be ordered in single parts, see chart.

Feature and benefits

- Alternate outlet ports for performance indicators
- Optional metering sections with visual cycle indicator
- Optional by-pass metering segment for addition or deletion of lubrication points

Applications

- Industrial machinery
- Metal forming machines
- Material handling machines



Technical data

Function principle	sectional metering device
Operating temperature	-26 to +200 °C; -15 to +400 °F
Operating pressure	max. 240 bar: 3 500 psi
Outlets	6 to 16
Lubricant	NLGI 0 to 2
oil and grease	per cycle and outlet: min. 0,082 cm ³ ; 0.005 in ³ max. 1,311 cm ³ ; 0.08 in ³
Metering quantity	
Material:	
housing	zinc plated steel
seals	FKM
Connection inlet	1/4 NPSF (F)
Connection outlet	1/8 NPSF (F)
Dimensions	min. 115 × 76 × 57 mm max. 232 × 76 × 57 mm min. 4.52 × 3 × 2.25 in max. 9.13 × 3 × 2.25 in
Mounting position	any

¹⁾ It is possible to reduce the number of outlets below the given minimum by crossporting or closing outlets.

NOTE

Further technical information, technical drawings, accessories, spare parts or product function descriptions available on SKF.com/lubrication.

Metering device

UV

UV baseplate and tie rod specifications ¹⁾

Outlets	Inlet section Order number	End section	Tie rod ¹⁾	Intermediate section Order number	Intermediate section quantity required	Metering valves quantity required
6	87918	87920	250290	87919	3	3
8	87918	87920	250291	87919	4	4
10	87918	87920	250292	87919	5	5
12	87918	87920	250293	87919	6	6
14	87918	87920	250294	87919	7	7
16	87918	87920	250295	87919	8	8

¹⁾ each tie rod model no. includes three tie rods and three fastening nuts

UV metering valve- single outlet S

Order number Standard	Right side cycle indicator	Designation	Metering quantity per outlet	
			cm ³	in ³
882051	–	05S	0,164	0.010
882101	–	10S	0,328	0.020
882151	–	15S	0,492	0.030
882201	882203	20S	0,656	0.040
882251	882253	25S	0,820	0.050
882301	882303	30S	0,983	0.060
882351	882353	35S	1,147	0.070
882401	882403	40S	1,311	0.080

UV metering valve - twin outlet T

Order number Standard	Right side cycle indicator	Designation	Metering quantity per outlet	
			cm ³	in ³
882052	–	05T	0,082	0.005
882102	–	10T	0,164	0.010
882152	–	15T	0,246	0.015
882202	882204	20T	0,328	0.020
882252	882254	25T	0,410	0.025
882302	882304	30T	0,492	0.030
882352	882354	35T	0,574	0.035
882402	882404	40T	0,656	0.040

Model 882000 UV by pass block optional:
by-pass block permits addition or deletion of lubrication points without disturbing existing installations. Includes mounting screws and NBR seals.

Plug and crossporting

Order number	Description
68645	closure plug
87905	single and crossport kit

Description

Closure plug to plug non-working outlets. External crossport kit connects alternate outlet ports to combine the volume of two metering segments through a single outlet.

Relief and performance indicators

Order number	Type	Disc colour	Pressure rating	
			bar	psi
87934	atmospheric relief	yellow	100	1 450
87935	atmospheric relief	red	120	1 750
87936	atmospheric relief	purple	224	3 250
87937	atmospheric relief	yellow/natural	255	3 700
87938	reset-type	–	35	500
87939	reset-type	–	69	1 000
87940	reset-type	–	103	1 500
87941	reset-type	–	138	2 000
87942	reset-type	–	207	3 000

Description

Atmospheric safety relief indicators. High pressure rupture disc, pressure and lubricant vents to the atmosphere. Reset-type Performance Indicators. High pressure extends indicator. Reset indicator after pressure is relieved. All with thread 1/8 NPTF (M).

Metering device

MC2-HP



Description

MC2-HP metering devices are modular type metering devices consisting of a baseplate part containing all inlet and outlet connections and a metering sections part containing alternate outlet ports for installation of performance indicators. The baseplate part has one inlet, three to eight intermediate and one end section hold via three tie rods. The metering sections part consists of three to eight metering sections (depending on number of outlets needed) which are fixed on the baseplate part. All parts have FKM O-ring seals in-between. There must be a minimum of three metering sections. The metering sections will have either single or twin outlets. Whenever a single metering segment or crossport plate is used, the unused outlet must be plugged. Metering device has to be ordered in single parts, see chart.

Feature and benefits

- Alternate outlet ports for performance indicators
- For mineral oil based or synthetic lubricants
- Optional metering sections with visual cycle indicator
- Optional by-pass metering segment for addition or deletion of lubrication points

Applications

- Gas engines
- Compressors
- For applications with high system back pressure

Technical data

Function principle	sectional metering device
Operating temperature	-26 to +200 °C; -15 to +400 °F
Operating pressure	max. 512 bar; 7 500 psi
Outlets	6 to 16
Lubricant	mineral and synthetic oil or grease NLGI 0 to 2
Metering quantity	per cycle and outlet: min. 0,098 cm ³ ; 0,006 in ³ max. 0,787 cm ³ ; 0,048 in ³
Material:	
housing	black chromate plated steel
seals	FKM
Connection inlet	1/4 NPSF (F)
Connection outlet	1/8 NPSF (F)
Dimensions	min. 129 × 86 × 48 mm max. 245 × 86 × 48 mm min. 5.09 × 3.38 × 1.87 in max. 9.63 × 3.38 × 1.87 in
Mounting position	any

¹⁾ It is possible to reduce the number of outlets below the given minimum by crossporting or closing outlets.



NOTE

Further technical information, technical drawings, accessories, spare parts or product function descriptions available on SKF.com/lubrication.

Metering device

MC2-HP

MC2-HP modular design

Outlets	Inlet section Order number	End section	Tie rod	Tie rod quantity required	Intermediate section Order number	Intermediate section quantity required	Metering valves quantity required
6	87955	87956	236640	3	87957	3	3
8	87955	87956	236641	3	87957	4	4
10	87955	87956	236642	3	87957	5	5
12	87955	87956	236644	3	87957	6	6
14	87955	87956	236645	3	87957	7	7
16	87955	87956	236646	3	87957	8	8

Note: use 68645 closure plug (1/8 NPT) to plug non-working outlets. Each 87956 end section contains 3 tie rod nuts

MC2-HP Metering valves single outlet

Order number Standard	W/right side cycle indicator	Designation	Metering quantity	
			cm ³	in ³
876061	•	06S	0,196	0.012
876091	•	09S	0,295	0.018
876121	876123	12S	0,393	0.024
876181	876183	18S	0,590	0.036
876241	876243	24S	0,787	0.048

MC2-HP Metering valves twin outlet

Order number Standard	W/right side cycle indicator	Designation	Metering quantity	
			cm ³	in ³
876062	•	06T	0,098	0.006
876092	•	09T	0,147	0.009
876122	876124	12T	0,197	0.012
876182	876184	18T	0,295	0.018
876242	876244	24T	0,393	0.024

Accessories

Plug and crossporting

Order number	Description
68645	closure plug
87905	single and crossport kit

Relief and performance indicators

Order number	Type	Colour	Pressure rating	
			bar	psi
87895	pin	yellow	109	1 450
87896	pin	red	120	1 750
87897	pin	orange	141	2 050
87885	reset	green	69	1 000
87886	reset	yellow	103	1 500
87887	reset	red	138	2 000
87888	reset	orange	172	2 500
87889	reset	blue	207	3 000

Description

Closure plug to plug non-working outlets. External crossport kit connects alternate outlet ports to combine the volume of two metering segments through a single outlet.

Description

Pin type performance indicators where high pressure ruptures internal disc and extends indicator. Reset-type indicator where high pressure extends indicator and resets after pressure is relieved. O-rings are FKM for both types.

Metering device

XL

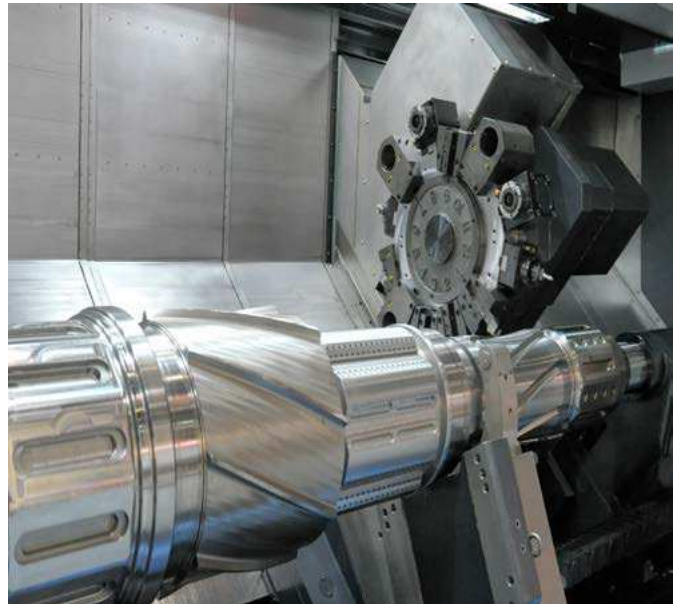

Description

XL metering devices are modular type metering devices. They consist of a baseplate as one piece and a modular metering sections part. The baseplate contains all inlet and outlet connections. The metering sections part consists of three to six metering sections (depending on number of outlets needed) which are fixed on the baseplate part. All parts have NBR-ring seals in-between. There must be a minimum of three metering sections. The metering sections will have either single or twin outlets. Whenever a single metering segment or a crossport or a singling plate is used, the unused outlet must be plugged. Metering device has to be ordered in single parts, see chart.

Feature and benefits

- Several sizes and outputs
- Can be used as primary metering device in conjunction with UV type
- Baseplate as one single piece

Applications

- Metal cutting machines
- Metal forming machines
- Wood-working machines
- Material handling machinery

Technical data

Function principle	segmented metering device
Operating temperature	0 to +120 °C; +35 to 250 °F
Operating pressure	max. 170 bar; 2500 psi
Outlets	6 to 12
Lubricant	NLGI 0 to 2
oil and grease	
Metering quantity	per cycle and outlet: min. 0,492 cm ³ ; 0.03 in ³ max. 4,92 cm ³ ; 0.3 in ³
Material:	
housing	zinc plated steel
seals	NBR
Connection inlet	1/4 NPTF (F)
Connection outlet	1/8 NPTF (F)
Dimensions	min. 136 × 127 × 70 mm max. 238 × 127 × 70 mm min. 5.34 × 5 × 2.75 in max. 9.38 × 5 × 2.75 in
Mounting position	any

¹⁾ It is possible to reduce the number of outlets below the given minimum by crossporting or closing outlets.



NOTE

Further technical information, technical drawings, accessories, spare parts or product function descriptions available on SKF.com/lubrication.

Metering device

XL

XL metering valve- single outlet S

Order number Standard	Designation	Metering quantity per outlet	
		cm ³	in ³
87026-03S	30S	0,983	0.060
87026-05S	50S	1,64	0.100
87026-08S	80S	2,62	0.160
87026-10S	100S	3,28	0.200
87026-12S	120S	3,93	0.240
87026-15S	150S	4,92	0.300

XL metering valve - twin outlet T

Order number Standard	Designation	Metering quantity per outlet	
		cm ³	in ³
87026-03T	30T	0,492	0.030
87026-05T	50T	0,820	0.050
87026-08T	80T	1,31	0.080
87026-10T	100T	1,64	0.100
87026-12T	120T	1,97	0.120
87026-15T	150T	2,46	0.150

Note: Model 87028 XL by-pass block:
optional by-pass block permits addition or deletion of lubrication points without disturbing existing installations. Includes mounting screws and FKM seals.

XL baseplate specifications

Order number	Outlets max.	Metering devices
87030-3	6	3
87030-4	8	4
87030-6	12	6

Note:
Use No. 67359 closure plug (1/4 NPT) to plug non-working outlets.

Accessories

Plug and crossporting

Order number	Description
67359	closure plug
87823	crossport kit
87824	singling kit

Relief and performance indicators

Order number	Type	Disc colour	Pressure rating	
			bar	psi
87934	atmospheric relief	yellow	100	1 450
87935	atmospheric relief	red	120	1 750
87936	atmospheric relief	purple	225	3 250
87937	atmospheric relief	yellow/natural	255	3 700
87938	reset-type	-	35	500
87939	reset-type	-	70	1 000
87940	reset-type	-	10	1 500
87941	reset-type	-	140	2 000
87942	reset-type	-	205	3 000

Description

Closure plug to plug non-working outlets. External crossport kit connects alternate outlet ports to combine the volume of two metering segments through a single outlet.

Description

Atmospheric safety relief indicators. High pressure rupture disc, pressure and lubricant vents to the atmosphere. Reset-type performance indicators. High pressure extends indicator. Reset indicator after pressure is relieved. All with thread 1/8 NPTF(M).

Metering device

LP2



Description

SKF's standard in lubrication pinions, the LP2 is manufactured from a sturdy, wear-resistant, polyurethane material. These pinions are available in seven different module sizes with various widths and inlet fittings, as well as in corrosion classes C3-H or C5-M-H.

Feature and benefits

- Modular design with 12, 14, 16, 18, 20, 22 or 24 modules
- Each segment of the pinion has its own lubricant channel
- Lubricates only where necessary (tooth flanks)
- Higher rotational speed of up to 80 min⁻¹
- Module widths from 80 to 240 mm

Applications

- Azimuth and pitch bearings in wind turbines
- Bucket wheel excavators in the mining industry
- Cranes in ports or on vessels

Technical data

Function principle	lubrication pinion
Operating temperature	-30 to +70 °C; -22 to 158 °F
Operating pressure	max. 150 bar; 2 175 psi
Number of teeth	8
Number of modules	12–24
Pinion width	80–300 mm
Lubricant	greases up to NLGI 2
Metering quantity	max. 2 000 cm ³ /min
Rotation speed	max. 80 min ⁻¹
Durability	min. 1 million revolutions
Material	PU (polyurethane)
Connection inlet	1/8 NPTF (F)
Deviation of the alignment of the lubrication pinion axis and the component to be lubricated	± 1 °
Maximum eccentricity of component to be lubricated	1 mm
Dimensions	min. 112 × 91 × 216 mm max. 270 × 314 × 357 mm min. 4.4 × 3.58 × 8.5 in max. 10.62 × 12.36 × 14.05 in
Sense of rotation	any
Mounting position	any

¹⁾ It is possible to reduce the number of outlets below the given minimum by crossporting or closing outlets.

NOTE

Further technical information, technical drawings, accessories, spare parts or product function descriptions available on SKF.com/lubrication.

951-231-003

Metering device

LP2

Identification code

L
P
2
-

-

-

Lubrication Pinion 2

Corrosion class
 3 = C3-H ¹⁾
 5 = C5-M-H ²⁾

Module size
 2 = Module 12 (for pinion width 08 to 14)
 3 = Module 14 (for pinion width 08 to 14)
 4 = Module 16 (for pinion width 10 to 16)
 5 = Module 18 (for pinion width 10 to 16)
 6 = Module 20 (for pinion width 12 to 20)
 7 = Module 22 (for pinion width 14 to 22)
 8 = Module 24 (for pinion width 14 to 24)

Pinion width
 08 = 80 mm
 09 = 90 mm
 10 = 100 mm
 ...
 24 = 240 mm

Screwing
 H = Screw plug (inlet closed) ³⁾
 A = Push-in connector Ø6 mm
 B = Push-in connector 90° Ø6 mm
 C = Screw-in connector Ø6 mm
 D = Screw-in connector Ø8 mm
 E = Screw-in connector Ø10 mm
 F = Adapter for G¹/₄ inlet
 G = Adapter for G³/₈ inlet
 Z = without screwing (G¹/₈ inlet) ⁴⁾

Bracket
 0 = without
 1 = straight

¹⁾ C3-H (moderate) Urban and industrial atmospheres, moderate sulphur dioxide levels, production areas with high humidity
²⁾ C5-M-H (very high) Marine, offshore, estuaries, coastal areas with high salinity
³⁾ Never close both inlets, only one inlet should be closed
⁴⁾ If no screwing is chosen (Z) the corrosion class of the lubrication pinion is C5-M-H, screwing to connect the lubrication pinion has to be added by the customer

Accessories

Screw plugs, screw-in connectors			
Order number	Designation	TubeØ	Corrosion class
		mm	
2260-00000020	Screw plug	–	C3-H
226-14160-3	Screw plug	–	C5-M-H
471-006-192	Screw-in connector	6	C3-H
223-13658-2	Screw-in connector	6	C5-M-H
223-10814-2	Screw-in connector	8	C3-H
408-423W-53	Screw-in connector	8	C5-M-H
223-13621-9	Screw-in connector	10	C3-H
223-13658-8	Screw-in connector	10	C5-M-H

Quick connectors, adapters			
Order number	Designation	TubeØ	Corrosion class
456-004-VS	Quick connector	6 mm	C3-H
226-14111-1	Quick connector	6 mm	C5-M-H
506-108-VS	Quick connector 90°	6 mm	C3-H
226-13756-9	Quick connector 90°	6 mm	C5-M-H
2230-00000032	Adapter	G ¹ / ₄	C3-H
2230-00000033	Adapter	G ¹ / ₄	C5-M-H
2230-00000034	Adapter	G ³ / ₈	C3-H
2230-00000035	Adapter	G ³ / ₈	C5-M-H



Overview of control units

Control units								
Product	Function type	Description	Voltage		Lubrication channels	Temperature		Page
			V DC	V AC		°C	°F	
LMC 101	Universal control and monitoring device	Universal control and monitoring device for progressive systems	12, 24	–	1	–40 to +65	–40 to +150	130
LMC 2	Electronic controller	Programmable for all kind of lubrication systems: time- or cycle- dependent lubrication	24	230	2	–10 to +70	+14 to 158	131
LMC 301	Lubrication monitor controller	Can handle up to 3 pumps and various types of lubrication systems. Function keys with menu display	24	90-264	1-3	–40 to +70	–40 to +158	132
EOT 2	Control and monitoring device	Easy time controller for lubrication pumps in progressive systems	12, 24	–	1	–25 to +70	–13 to +158	134
IG 502	Universal electronic controller	Programmable for progressive lubrication systems: time- or cycle- dependent lubrication, with timer, counter or monitoring function for pressure or cycle switches	12, 24	–	1	–25 to +75	–13 to +167	135
EXZT/IGZ51	Universal electronic controller and monitoring device	Universal control and monitoring device for stationary industrial application installed in a switching cabinet	–	100-240	1	0 to +60 0 to +60	+32 to 140 +32 to 140	136 136
ST-102	Lubrication control center	Can be used within single-, dual-line or progressive lubrication systems. Includes a user interface for monitoring and controlling the lubrication system	12, 24	–	1-2	–30 to +80	–22 to +176	138
ST-1240-Graph-4	Lubrication control center	Can handle four channels, single-line or progressive lubrication systems. Configuration can be set in the field by the color touchscreen display. Pressure switches, pressure transmitters or piston detectors can be used in all channels	–	93-132, 186-264	1-4	0 to +50	+32 to +122	139
ST-2240-LUB	Lubrication control center (modular)	This modular control centre can operate 1 to 14 channels of single-line, dual-line and progressive lubrication systems. Configuration can be set in the field by touchscreen display.	–	93-132, 186-264	1-14	0 to +50	+32 to +122	140
LRM 2	Control unit with remote control	The LRM2 can communicate with a pump or group of pumps on the same type of lubrication system. LRM utilizes a SIM card to send and receive text messages that allow system control.	12/24	–	1-3	–30 to +70	–22 to +158	142

LMC 101



Description

The LMC101 is a universal control and monitoring device suitable for single-line and progressive lubrication systems. Designed for off-road and mobile equipment only in drivers cabin use or industrial indoor use, this controller also can be utilized for any low-voltage lubrication application. Time or controller mode can be set for both systems. The LMC 101 must be programmed via USB connection to a PC. In timer mode, the lubrication cycle ends when the pre-assigned time has expired. In controller mode, the lubrication cycle ends when the pressure switch, pressure transducer or piston detector actuates. The system allows pressure to dissipate to the end of the supply line once pressure at the pump is reached.

Feature and benefits

- FoR 12 and 24 V DC systems
- Time or controller mode
- Various alarm condition settings
- Programming, data logging, and reporting
- Controller must be programmed via USB connection to PC
- Manual lubrication pushbutton

Applications

- Off-road equipment
- Mobile equipment
- Indoor industrial machinery
- Food and beverage industry
- Single-line and progressive systems

Technical data

Function principle	control and monitoring device
Operating temperature	-40 to +66 °C; -40 to +150 °F
Input	12 and 24 V DC, -20% / +30%
Pump relay contact	20 A at 30 V DC
Vent relay contact	2 A at 30 V DC
Alarm relay contact	2 A at 30 V DC
Enclosure rating	NEMA 12
Off time (adjustable)	15 sec to 99 h
On time (adjustable)	15 sec to 99 h
Protection class	IP 52
Dimensions	186 × 120 × 59 mm
Mounting position	7.3 × 4.7 × 2.3 in any

Order information

Order number	Description
--------------	-------------

86535	Single line and progressive lubrication controller
--------------	--



NOTE

For further technical information, technical drawings, accessories, spare parts or product function descriptions, see the following publication available on SKF.com/lubrication:

15556 EN, 15625 EN

Control units

LMC 2



Description

The LMC 2 is a controller for the electronic management and monitoring of lubrication systems. It combines the advantages of a specially developed printed circuit board (PCB) and a PLC in an economical, compact unit. For progressive systems, it controls the pump unit and the metering devices.

Feature and benefits

- Integrated, flexible lubrication programs
- 8 inputs / 5 outputs; suitable for complex lubrication systems
- Time- or cycle-dependent control of lubrication intervals
- Can be interfaced with common field bus systems

Applications

- General lubrication systems with a pump and pulse generator
- Railway
- Food and beverage
- ChaLMCin lubrication systems like Lincoln Cobra and PMA
- Multi-line as well as dual-line, single-line and progressive systems

Technical data

Function principle	control and monitoring device
Operating temperature	-10 to +70 °C, -14 to +158 °F
Supply voltage	12 or 24 V DC
Inputs	max. 8 digital inputs
Outputs	4 relay outputs, 1 electronic
Operating voltage	depending on model: 230 VAC, 24 V DC (± 10%)
Standard	CE
Protection class	IP 54
Dimensions	200 × 120 × 90 mm, 7.9 × 4.7 × 3.5 in
Mounting position	any

Order information

Order number	Description
236-10567-6	LMC 2; 230 AC (230 V AC)
236-10567-5	LMC 2; 24 DC (24 V DC)

For use with electric operated 3-phase pump must order motor starter separately.

NOTE

For further technical information, technical drawings, accessories, spare parts or product function descriptions, see the following publication available on SKF.com/lubrication:

14004 EN

Control unit

LMC 301



Description

The LMC 301 is a compact, modularly expandable control and monitoring device. It is equipped with an LCD display and six functional keys for programming, parameter setting and signalization. The user is guided through the setup menu. Additionally, there is simple-to-use PC software for parameter setting and diagnostics available.

Feature and benefits

- Integrated, flexible lubrication programs
- Main device with 10 digital inputs, for 3 lubrication pumps and max. 6 pulse transmitters
- Up to 7 slave/extension with additional inputs for max. 10 pulse transmitters
- Three lubrication pumps can be controlled and monitored
- Can be connected to universal pulse generators

Applications

- General and heavy industry
- Steel industry
- Mining – stationary and mobile excavators
- Food and beverage
- Multi-, dual-, single-line and progressive systems

Technical data

Function principle	control and monitoring device
Operating temperature	VAC: -10 to + 50 °C; +14 to 122 °F VDC: -40 to +70°C; -40 to 158 °F
Inputs	10 count, short-circuit proof, 2 with analog
Outputs	8 count, relay outputs NO-contact 8 A, 2 of which up to 15 A
Operating voltage	depending in model 100-240 VAC, 24 VDC ±20%
Standard	CE; UL; CSA
Protection class	IP 65
Dimensions	270 × 170 × 90 mm 10.7 × 6.7 × 3.5 in
Mounting position	vertical

Order information

Order number	Description
086500	LMC 301; 24 V DC, master, incl. LCD display
086501	LMC 301; 100-240 VAC, master, incl. LCD display
086502	LMC 301; 24 V DC, I/O board, slave, without display
086503	LMC 301; 100-240 AC, I/O board, slave, without display



NOTE

For further technical information, technical drawings, accessories, spare parts or product function descriptions, see the following publication available on SKF.com/lubrication:

15967 EN, 951-150-029 EN

LMC 301 - Accessories



LMC 301 motor relay assembly

Order number	Description
236-10850-7	with motor starter 0,4–0,6 A
236-10850-8	with motor starter 0,6–1,0 A
236-10850-9	with motor starter 1,0–1,6 A
236-10980-6	with motor starter 2,4–4,0 A

LMC 301 housing

Order number	Description
086504	door housing, complete
086505	cable USB

General LMC 301 accessories

Order number	Description
086506 086507	PG-M20 Cable gland kit, IP 65 Multiple cable gasket set (3 x) Cable gasket set (3 x)
3515-10-6020 3515-10-6620	Cable glands PG-M20; complete, with cap nut, cable gasket set, screw plug cartridge Cable gasket set; 2-wire, Ø 0.6 mm Cable gasket set; 4-wire, Ø 0.5 mm
3515-10-7620 3515-10-6320 3515-10-6120	Blind plug Gasket Counter nut
3515-07-6120 3515-10-2021 3515-07-2022 179-990-486 236-11066-1	Conduit glands, IP 65, with flexible metal tube (FMC), UL approved Conduit glands AMG-M 20 x 1,5; UL 514B Counter nut M 20 x 1,5 Protection hose, liquid-proof protective; UL 360 (sold by the metre, when ordering specify the required length) Fuse, blade-type, FK1 3A (32 V) according to ISO 8820-3 Battery, 3 V lithium button cell, model CR3032
www.skf.com/LMC301	LMC 301 software, free download

¹⁾ The installation of the cable glands and cable sets to be provided and done by the customer. The customer is responsible for proper installation.

Control units

EOT-2



Description

The EOT-2 controller is designed to control lubrication pumps during interval operation in multi-line systems. Rotary switches on the printed circuit board may be used to adjust lubrication time in seconds or minutes and pause time in minutes or hours. The EOT-2 is suitable for retrofit installation and often is used when a lubrication pump has no integrated control unit. Additional lubrication cycles can be triggered via a pushbutton.

Feature and benefits

- Easy-to-use controller for installation and outdoor
- Suitable for retrofit
- Easy time setting and function control

Applications

- Lubrication pumps without integrated controller
- Agricultural machinery, chain lubrication systems
- Simple lubrication systems in machines
- In connection with motor relay assembly; also preferred for three-phase multi-line pump units



NOTE

For further technical information, technical drawings, accessories, spare parts or product function descriptions, see the following publication available on SKF.com/lubrication:
951-181-005 EN

Technical data

Function principle	control and monitoring device
Operating temperature	-25 to +70 °C, -13 to +158 °F
Supply voltage	12 or 24 V DC
Current draw	max. ≤ 7 A
Outputs	transistor / N.O.
Pause time	min. 4 min max. 15 h
Running time	min. 8 sec max. 30 min
Standard	CE
Protection class	IP 65
Dimensions	122 x 118 x 56 mm, 4.80 x 4.65 x 2.00 in
Mounting position	any

Order information

Order number	Description
--------------	-------------

664-34135-7	EOT-2 controller, for one pump only
--------------------	-------------------------------------

Control units

IG 502-2E +...



Description

The IG 502-2-E ... is a universal control and monitoring device for vehicles and is suitable for centralized lubrication in progressive and single-line systems. The compact device is equipped with a display panel for parameter settings and function monitoring. Different operating modes, such as timer, counter and monitoring functions for pressure and cycle switches, are programmable. The device has its own data memory to be independent of supply voltage. To avoid environmental influences, it is advisable to install the device inside a cabinet.

Feature and benefits

- Universal control and monitoring device
- Compact design
- Easy to operate
- Different operating modes, such as timer, counter and monitoring functions
- Red LED failure indicator also shows failure cause
- Integrated counters for permanent operation, failed hours and working-hour meter show system life cycle
- PIN lockout feature to prevent unauthorized programming changes

Applications

- Commercial vehicles
- Construction machines
- Farm machinery

Technical data

Function principle	control and monitoring device
Operating temperature	-25 to +75 °C, -13 to +167 °F
Storage temperature	-10 to +70 °C, 14 to 158 °F
Control voltage max.	12 or 24 V DC
Contact load connector M	5 A at 12 or 24 V DC
SL-output	4 W
Fuse protection	max. 5 A
Pause time	adjustable, 0,1 h to 99,9 h
Pump running time	adjustable, 0,1 min to 99,9 min
Pulse time	adjustable, 1 to 999
Operation hours storage	0 to 99999,9 h
Operation- failed hours storage	0 to 99999,9 h
Protection class	IP 20 DIN 40050, plug IP 00
Dimensions	138 × 65 × 40 mm 5.43 × 2.56 × 1.57 in

Order information

Order number	Description
IG 502-2-E+912	ControlleR 12 V DC
IG 502-2-E+924	Controller 24 V DC
997-000-185	Wire set



NOTE

For further technical information, technical drawings, accessories, spare parts or product function descriptions, see the following publication available on

SKF.com/lubrication:

1-1700-2-EN, 951-180-002-EN

IGZ / EXZT



Description

IGZ 51 and EXZT universal electronic control and monitoring devices are used in multi-line and progressive lubrication systems and are available in two voltage versions. Developed for stationary industrial applications, these devices may be installed in a switching cabinet or internally in a compact lubrication unit. They can be used as time-dependent or pulse-dependent controllers to initiate a lubrication cycle.

The EXZT devices control the pump running time and monitors simultaneously the strokes of the pulse generator or sensor of the metering device. All devices have custom-built functions integrated and can be set to meet system requirements.

Feature and benefits

- Combined universal control and monitoring device
- Easy installation by top hat rail mounting
- Adjustable operating modes
- Time operation or load-dependent machine-stroke operation
- Low-level control and EPROM included

Applications

- Stationary industrial applications
- Installation in switching cabinet of stationary general industry machines

Technical data

Function principle	control and monitoring device
Operating temperature	0 to +60 °C, +32 to 140 °F
Output voltage	24 V DC +10%/-15%
Connector for class	II
Protection class	IP 30, clamps IP 20
Dimensions	70 × 75 × 110 mm 2.7 × 3 × 4.3 in

Version + 471

Input voltage	100 – 120 V AC; 200 – 240 V AC
Input current rated	70 mA / 35 mA
Power input	8 W
Frequency	50 – 60 Hz
Fuse	max. 6.3 A
Switching current	max. 5 A
Input voltage sensors	24 V DC

Version + 472

Input voltage	20 – 24 V DC; 20 – 24 V AC
Input current rated	75 mA at max. fan-out of 250 mA
Power input	5 W
Frequency	DC or 50 – 60 Hz
Fuse	max. 6.3 A
Switching current	max. 5 A
Input voltage sensors	24 V DC
Mounting position	any



NOTE

For further technical information, technical drawings, accessories, spare parts or product function descriptions, see the following publication available on SKF.com/lubrication:

1-1700-1 EN, 1-1700-2 EN, 951-180-001 EN

Control unit

IGZ / EXZT

Order information ¹⁾

Order number	V DC	V AC; 50-60 Hz	pump delay time adjustable	pulse monitoring (interval time)	prelubrication	power failure memory
EXZT2A03-E+471	–	100-120; 200-240	•	–	–	–
EXZT2A03-E+472	20-24	–	•	–	–	–
EXZT2A06-E+471	–	100-120; 200-240	•	•	–	–
EXZT2A06-E+472	20-24	–	•	•	–	–
IGZ 51-20-E+471	–	100-120; 200-240	–	–	–	–
IGZ 51-20-E+472	20-24	–	–	–	–	–
IGZ 51-20-S2-E+471	–	100-120; 200-240	–	–	–	•
IGZ 51-20-S2-E+472	20-24	–	–	–	–	•
IGZ 51-20-S7-E+471	–	100-120; 200-240	–	–	–	•
IGZ 51-20-S7-E+472	20-24	–	–	–	–	•
IGZ 51-20-S8-E+471	–	100-120; 200-240	–	–	•	•
IGZ 51-20-S8-E+472	20-24	–	–	–	•	•

¹⁾ All models are with lubricant level monitoring, pulse generator; pump runtime limitation, adjustable interval and monitoring time

Control units

ST-102



Description

The ST-102 controller is designed for the control and monitoring of lubrication systems in vehicles with a 12 or 24 V DC power supply. It is a one-channel lubrication control center for systems with air-operated or electrical pumps. The ST-102 is suitable for environments with temperatures ranging from -30 to $+80$ °C (-22 to $+176$ °F) and features an IP 30 protection class. All lubrication configurations can be set in the field by the user.

Feature and benefits

- Available for 12 or 24 V DC
- Suitable for operational environments in extreme temperatures
- One-button user interface

Applications

- Vehicles
- Construction machinery
- Agricultural machinery
- Dual-line, progressive and single-line lubrication systems

Technical data

Function principle	control and monitoring device
Operating temperature	-30 to $+80$ °C; -22 to $+176$ °F
Power supply	12 and 24 V DC
Input	4 digital
Output	4 digital
Interface	one-button user interface with indication lights
Protection class	IP 30
Dimensions	$26 \times 60 \times 160$ mm $1.02 \times 2.36 \times 6.3$ in

Order information

Order number	Designation	Description
11500610	ST-102	1-channel version for single-line, progressive and dual-line systems
11500612	ST-102 C2P	2-channel version for progressive lubrication systems



NOTE

Further technical information, technical drawings, accessories, spare parts or product function descriptions available on SKF.com/lubrication:

6408 EN

Control units

ST-1240-GRAPH-4



Description

The ST-1240-GRAPH-4 is a four-channel lubrication control centre that supports any combination of single-line and progressive lubrication systems. The lubrication channels can be zones, separated by shut-off valves, or lubrication systems with separate pumping centres (max. 2) and varying lubricants. The ST-1240 control centre enables configuration in the field via color touchscreen display.

Feature and benefits

- Designed especially for progressive systems
- Grease spraying control with air monitoring
- IP 65 protection rating
- Color touchscreen
- Remote control options (mobile app, webgate)

Applications

- Stationary machines
- General industry
- Steel industry

Technical data

Function principle	control and monitoring device
Operating temperature	0 to +50 °C; +32 to 122 °F
Lubricant	oil and grease
lubrication circuits	4
Operating voltage	93 to 132 V AC, 186 to 264 V AC;
Operating voltage frequency	(± 10%)
Operating current	47 to 63 Hz
Control voltage	5,4 A/115 V AC, 2,2 A/230 V AC
Overload protection	24 V DC, ± 10%
Cable connection	automatic fuse, 6 A
Interface	screw connections for 2,5 mm ² wires 5.7 in TFT touch screen , 320 x 240, 64k colors, ethernet and USB port mobile app for monitoring, RS-422 Modbus port
Protection class	IP 65
Dimensions	380 x 300 x 210 mm 14.9 x 11.8 x 8.3 in

Order information

Order number	Description
12380200	ST-1240 GRAPH-4 control centre



NOTE

Further technical information, technical drawings, accessories, spare parts or product function descriptions available on SKF.com/lubrication:

12404 EN

Control units

ST-2240-LUB



Description

ST-2240-LUB-6 and ST-2240-LUB-14 lubrication control centers are suitable for use in dual-line lubrication systems, as well as single-line and progressive systems. These units have a touchscreen display and are only differentiated by the cabinet size and maximum number of lubrication channels served. The ST-2240-LUB-6 controls up to 6 separate lubrication channels, while ST-2240-LUB-14 controls up to 14 channels, each having independent lubrication parameters and/allows use of different lubricants if required. The lubrication system is adjustable at field site by adding or reducing channel modules, and configuration can be changed in the field by the user. Pressure switches and transmitters or piston detectors can be used in all channels. Also the new lubricant low level ultrasonic sensor is supported.

Features and benefits

- Versatile and durable, automatic pump change (Dualset)
- Modular units provide easy system modification
- Compatible with ultrasonic low level sensor
- Grease spraying control with air monitoring
- Compatible with SKF Doser monitor
- Remote control options (fieldbus, mobile app, webgate)

Applications

- Steel and mining industry
- Pulp and Paper industry
- Food and beverage

Technical data

Function principle	control and monitoring device
Operating temperature	0 to +50 °C, +32 to +122 °F
Lubricant channels	1-14
Supply voltage	115/230 VAC, automatic range selection
Supply voltage frequency	47 to 63 Hz
Control voltage	24 V DC, ± 10 %
Overload protection	automatic fuse, 6 A
Cable connection	screw terminals for 2,5 mm ² wires
Protection class	IP 65
Interface	5.7" TFT touch screen , 320 × 240, 64k colors, ethernet and USB port mobile app for monitoring
Data logging	Log files on USB memory
Fieldbus	ModbusTCP slave, other protocols on request
Alarm Outputs	relays K1 & K2: potential-free change over contact; maximum load 230 V/1 A; channel modules: potential-free contact; maximum load 50 V DC/1A
Dimensions	600 × 600 × 250 mm 23.6 × 23.6 × 9.8 in



NOTE

Further technical information, technical drawings, accessories, spare parts or product function descriptions available on SKF.com/lubrication:

PUB LS/P2 17950 EN

Control units

ST-2240-LUB

Order information		
Order number	Designation	Lubrication channels
12380760	ST-2240-LUB-6 control center	1-6
12380765	ST-2240-LUB-14 control center	1-14
12501270	CM channel module	

Control units

LRM 2



Description

SKF's LRM2 lubrication remote monitor is designed for use with lubrication systems that cannot be checked daily due to the nature or position of the specific application. Compatible with oil or grease, the monitor can be used on single-line, dual-line and progressive lubrication systems. The LRM2 can communicate with a pump or group of pumps on the same type of lubrication system. LRM utilizes a SIM card similar to those found in cell phones and tablets to send and receive text messages via iOS or android mobile devices or via e-mail to a computer. The monitoring system can transmit alert messages to a random number of e-mail or mobile phone contacts. These contacts can be grouped based on the message type. The LRM2 features two digital inputs and outputs and sends both low-level and fault messages. Also, the monitor can be used to start an additional lubrication cycle and can be reset by sending messages from the mobile device. In addition, you can access system information by using your web browser without having to install special software. The LRM is suitable for wind energy, railroad wayside, cable car and wastewater treatment applications, as well as other industries.

Features and benefits

- Two digital inputs and outputs
- Antenna is packed inside housing; optional external antenna can be ordered
- LRM2 module is available without housing for mounting in existing control box

Applications

- Wind energy generators
- Wastewater treatment applications

Technical data

Function principle	control and monitoring device with remote control
Operating temperature	-30 to +70 °C; -22 to +158 °F
Storage temperature	-40 to +70 °C; -40 to +158 °F
Air humidity	0–95%
Protection class	IP 66
Screwed cable gland	M16
Clamping zone of cable strand	Ø4–10 mm; 0,16–0,39 in
LRM2 clamping zone	0,25–2,5 mm; 0,0098–0,098 in
Power supply	12–24 V DC (± 20%)
Power consumption	max. 3 W
Min. installation space	420 × 220 × 350 mm
Dimensions	
LRM 2 without enclosure	150 × 90 × 61 mm; 10.67 × 6.73 × 10.31 in
Enclosure	271 × 171 × 262 mm 16.53 × 8.66 × 13.78 in
Mounting position	any



NOTE

Further technical information, technical drawings, accessories, spare parts or product function descriptions available on SKF.com/lubrication.

PUB LS/P2 17887 EN; 951-181-022-EN

Control units

LRM 2

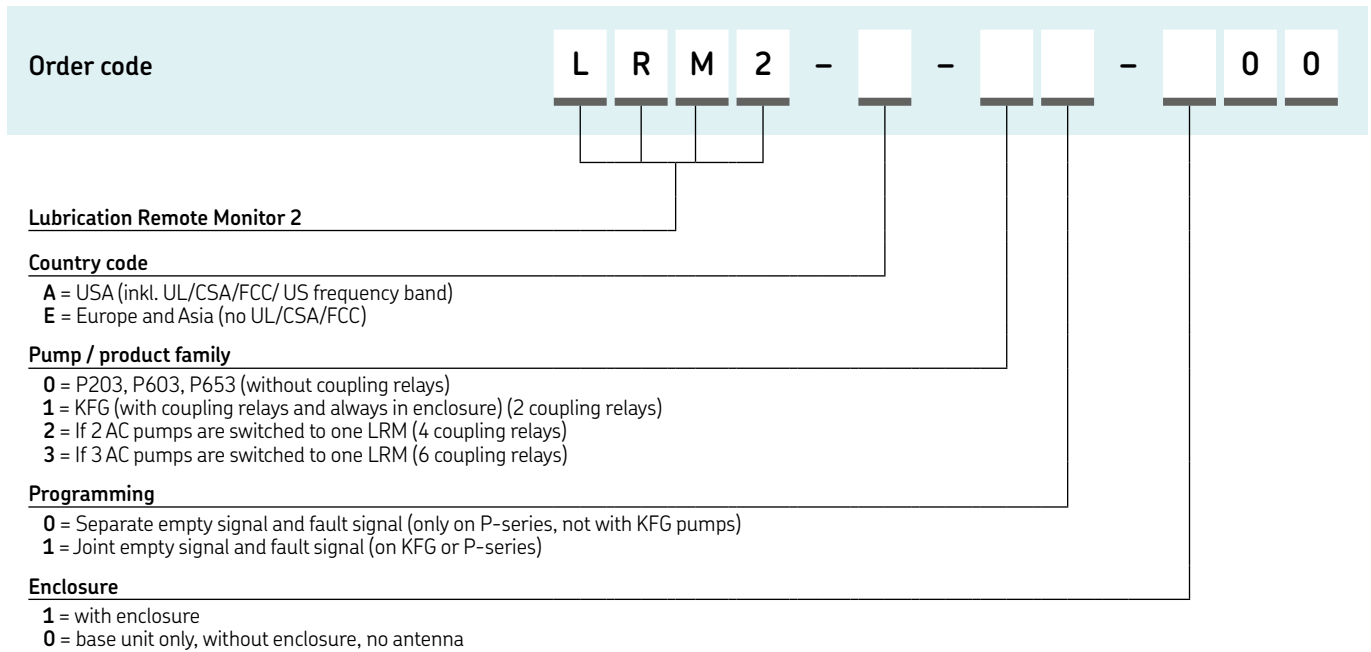

Order example

LRM2-E-00-100

- Lubrication Remote Monitor 2
- For use in Europe and Asia
- Pump versions P203, P603, P653
- Low-level and fault signal separately
- With enclosure

Antenna

Order number	Designation
236-11335-8	2G/3G Magnetic base antenna (3 m length)



Overview of monitoring devices

Control units							
Product	Function type	Description	Voltage		Operating temperature		Page
			V DC	V AC	°C	°F	
HCC	Monitoring device for hose connections	Additional control and monitoring system for progressive systems to identify failures in hose connections	12, 24	–	-50 to +70	-58 to +158	146
Smart Plug lubrication control	Multifunctional monitoring device	Direct adaption between sensor and connecting cable. Configurable by PC via IR interface converter	10 to 30	–	0 to +60	+32 to 140	148
Universal piston detector	Piston detector	Allround magnetic sensor for all SKF metering devices in progressive systems	10 to 30	–	-40 to +85	-40 to +185	149
SP/SFE30	Pulse monitor	To monitor oil and grease volumetric flow rates	0 to 30	–	+15 to 70	+5 to 158	150
EWT2A	Pulse monitor	Monitors up to 3 pulse generators	24	115, 230	0 to +60	+32 to 140	151
234-11145-3/4/5/9	Digital pressure switch	Pressure switch for extensive lubrication point monitoring	18–36	–	-25 to 125	-13 to 257	152
234-10825-8	Digital pressure switch	Pressure switch for simple lubrication point monitoring	30–250	125, 250	-25 to +85	-13 to 185	153

Monitoring devices

HCC



Description

The hose connection control (HCC) is intended to monitor electrically conductive, high-pressure lubrication hoses for line breakage. If there is a fault in the main line or feed lines, the unit alerts the machine operator immediately. Operation of the HCC is not affected by line lengths, ambient temperature, pressure differential or pressure losses. Utilizing non-conductive lubricants or hydraulic fluids, this monitoring system has an operating pressure of up to 300 bar (4 350 psi) and can be used in temperatures ranging from -40 to $+70$ °C (-40 to $+158$ °F).

Feature and benefits

- Immediately detects hose ruptures
- Expandable at any time
- Easy retrofit in existing lubrication systems
- Monitors difficult-to-access hoses to lubrication points
- Common LED signal of all connected hoses on the display

Applications

- Construction and mining machines; cranes
- Wood-handling machines
- Forklifts, reach stackers and machines with movable units or accessories
- Agriculture

Technical data

Function principle	monitoring device for hose connections
Operating temperature	Isolator: -50 to $+70$ °C; -58 to $+158$ °F Controller: -25 to $+70$ °C; -13 to $+158$ °F Controller storage: -40 to $+70$ °C; -40 to $+158$ °F
Power supply	12/24 V DC
Monitored hose per monitoring unit	max. 15 pieces at 12 V DC
Positive ok signal	max. 24 pieces at 24 V DC
Signal cable to one cut-off connector	12/24 V PNP
Signal cable at cut-off	20 m; 65 ft
Protection class	approx. 150 mm; 5.90 in
Dimensions	IP 65 100 × 85 × 40 mm 3.93 × 3.34 × 1.57 in



NOTE

Further technical information, technical drawings, accessories, spare parts or product function descriptions available on SKF.com/lubrication:

13615 EN

Monitoring devices

HCC



Order information

Order number	Description
236-10986-1	HCC, evaluation unit
236-10153-3	HCC, cable 20 m, 1-core w. superseal plug
532-34839-2	HCC, endlink HCC DN 8-10L-E
532-37731-1	basic kit consisting of above three parts
532-34839-6	HCC, endlink HCC DN 4-6L-E
532-34839-3	HCC, interlink HCC DN 8-10L-I
532-34839-5	HCC, interlink HCC DN 4-6L-I

Accessories

HCC Hose

Order number	Description
1110-0000007	hose, PA DN 4 TBF204CU, sold per meter
226-11169-1	hose stud D6/NW4 C straight

Monitoring devices

SmartPlug lubrication control



Description

The SmartPlug lubrication control is a simple, multifunction switching device that can be used as a timer or pulse counter when no standard timer is available. Operation with on-delay or signal-inverter functions also is possible. Suitable for retrofitting, the SmartPlug can be installed easily in an existing electrical system. Its complimentary programming timer can be adapted directly between a sensor and the connecting cable.

Feature and benefits

- Simple, cost-effective, multifunction switching device
- Acts as timer or pulse counter
- Easy installation in electrical systems
- Suitable for retrofitting in existing systems
- Free programming timer

Applications

- Progressive systems where additional monitoring of separate lubrication circuits is required
- Counter for chain lubrication systems
- Forklifts
- Chain lubrication

Technical data

Function principle	multifunctional monitoring device
Operating temperature	0 to +60 °C; +32 to 140 °F
Operating voltage UB	10 – 30 V DC
Residual ripple within UB	max. 10%
Power consumption	< 10 mA, no load
Current consumption own	< 10 mA
Input resistance	>10 kOhm
Input frequency	max. 10 kHz, at ppp 1:1
Switching input	PNP/NPN adjustable
Output current	max. 400 mA
Drop-out delay	
Teachable time	min. 1 ms; max. 65 535 ms
Counter	
Counting time	min. 1 pulse; max. 65 535 pulses
Periodic monitoring	
Teachable time	min. 10 sec; max. 655 350 sec
Short-circuit protection	yes
Standard	CE
Protection class	IP 67
Dimensions	Ø 20, l=60 mm Ø 0.79, l=2.36 in

Order information

Order number	Description
234-10151-8	Smart Plug MFU 12 P4-X01 output PNP
234-10151-9	IR Interface converter for configuration by PC



NOTE

Further technical information, technical drawings, accessories, spare parts or product function descriptions available on SKF.com/lubrication.

Universal piston detector



Description

The universal and bipolar piston detectors are position sensors that are screwed into the metering device together with the relevant pressure-resistant adapter. The sensors detect the piston by means of the closed adapter without coming into direct contact with it. They adjust themselves independently after several distribution strokes. The universal piston detector automatically detects the customer's plug or cable assignment, 2-wire or 3-wire version (with cable break protection). The bipolar piston detector is only available in a 2-wire version. The signal voltage can be applied to either pin 1 or pin 4, which means this sensor can be used for mobile applications such as vehicles or agricultural and construction machinery.

Feature and benefits

- Timer setting on external controller detects operational function signal
- Counter setting is used as cycle switch with an external controller

Technical data

Function principle	piston detector
Operating temperature	-40 to +85 °C; -40 to +185 °F
Electrical connection	3 wire DC PNP; 2 wire PNP/NPN
Operating voltage	10 to 36 V DC
Current draw	5 mA, only in 3 contact operation
Connector for class	III
Reverse voltage protection	yes
Current rating	100 mA
Overload proofed	yes
Switching frequency	10 Hz
Standard	CE, UL, CSA, E1
Protection class	IP65; IP68; IP69 K
Dimensions without socket	Ø 12 mm, l = 52 mm, Ø 0.47 in; l = 2.052 in

Order information

Order number	Description
234-13163-9	Universal piston detector
234-11454-1	Bipolar piston detector
237-13442-4	Cable with M12x1 socket

Kits with piston detector, O-ring and adapter for lubricant metering devices

Order number	Suitable for metering device	Type
24-0159-6025	VP / PSG2	Universal
24-0159-6021	VP	Bipolar
24-0159-6024	VPK / PSG1	Universal
24-0159-6022	VPK	Bipolar
24-0159-6023	VPB	Universal
24-0159-6028	VPB	Bipolar
24-0159-6026	PSG3	Universal
519-85224-1	SSV / SSVL / SSSD / SSSDL / VS...	Universal



NOTE

Further technical information, technical drawings, accessories, spare parts or product function descriptions available on SKF.com/lubrication:
17645 EN; 951-150-032

Monitoring devices

SP/SFE30



Description

SP/SFE30 pulse generators are designed to monitor oil and grease volumetric flow rates. The switching pulses are generated at a rate proportional to the volumetric flow, and the pulses from the pulse generator are evaluated by a downstream control unit. SP/SFE30/6GL pulse generators have been approved by German Lloyd for use on ships.

Feature and benefits

- For oil and grease NLGI 1
- Operating pressure of up to 600 bar (8 700 psi)
- Germanischer Lloyd-approved device available

Applications

- Progressive lubrication systems
- General stationary industry machines
- Ships
- Wind energy systems
- Glass industry

Technical data

Order number	
SP/SFE/ 30/5	24-2583-2516
SP/SFE 30/6 GL with cable set	24-2583-2517
SP/SFE 30/3003Atex	24-2583-2526
Function principle	pulse monitor
Operating temperature	-15 a +70 °C; +5 a +158 °F
Operating pressure	4 to 600 bar; 58 to 8 700 psi
Lubricant	oil: viscosity minimum 12 mm ² /s; grease: NLGI 1
Volumetric flow range	0,1 to 50 cm ³ /min 0.006 in ³ to 3.051 in ³ /min
Volume/pulse	0,34 cm ³ ; 0.021 in ³
Contact type	reed contact
Connection	SP/SFE 30/5: plug DIN43650 SP/SFE 30/6 GL: cable
Switching voltage	0 to 30V DC
Switching capacity	10 W with V AC/V DC
Protection class	IP 65
Dimensions	65 × 170 × 35 mm 2.56 × 6.69 × 1.37 in

SP/SFE30 Accessories

Order number	Description	Tube
406-411	straight connector G 1/4	∅ 6 mm
96-1108-0058	straight connector G 1/4	∅ 8 mm



NOTE

Further technical information, technical drawings, accessories, spare parts or product function descriptions available on SKF.com/lubrication:

1-3009-EN, 1-3018-EN, 951-230-012 EN

Monitoring devices

EWT2A



Product description

The EWT2A series of universal pulse monitoring devices can be used in all standard SKF lubrication systems. The pulse, generated from a progressive metering valve sensor, a pulse generator or a rotary gear sensor, must be received within a pre-selected and defined value. Depending on the selected version, a minimum and a maximum value can be monitored simultaneously for two or three pulse inputs. The EWT2A pulse monitoring devices are available in two voltage versions and may be installed in a switching cabinet. All devices have custom-built functions integrated and can be set to meet system requirements.

Features and benefits

- Easy installation by top hat rail mounting
- Adjustable operating modes
- Monitoring time 6-90 seconds
- Settings possible from 0,01 to 2 500 pulses/minute

Applications

- In connection with a pulse generator for oil and grease to reliably monitor lubricant flow

Technical data

Function principle	universal electronic control and monitoring device
Operating temperature	0 to +60 °C +32 to 140 °F
Output voltage	24 V DC +10% /-15%
Dimensions	70 x 75 x 110 mm 2.7 x 3 x 4.3 in

Version + 471

Input voltage	100-120 V AC; 200-240 V AC
Input current rated	70 mA/35 mA
Power input	8 W
Frequency	50 - 60 Hz
Fuse	max. 6.3 A
Switching current	max. 5 A
Output voltage sensors	24 V DC

Version + 472

Input voltage	20 to 24 V DC; 20 to 24 V AC
Input current rated	75 mA at max. fan-out of 250 mA
Power input	5 W
Frequency	DC or 50 - 60 Hz
Fuse	max. 6.3 A
Switching current	max. 5 A
Output voltage sensors	24 V DC

Order information

Order number	Description
EWT2A01-S1-E+471	for up to 3 pulse generators, 115/230 V AC
EWT2A01-S1-E+472	for up to 3 pulse generators, 24 V DC
EWT2A04-S1-E+471	for up to 2 pulse generators, 115/230 V AC
EWT2A04-S1-E+472	for up to 2 pulse generators, 115/230 V AC



NOTE

For further technical information, technical drawings, accessories, spare parts or product function descriptions, see the following publications available on SKF.com/lubrication:

1-1700-5 EN, 951-180-001 EN

Monitoring devices

234-11145-3/4/5/9



Description

These virtually maintenance-free electronic pressure sensors are suitable for pressure measurements for gases and fluids. They are user friendly and can be applied easily in standard or superior applications. The space-saving housing is pivotable up to 320° for optimal readability of the 4-digit, digital display. One or two switching outputs and an analog output signal for switching point and hysteresis. Both can be adjusted via push buttons. Different value units such as bar, mbar, psi or MPa can be selected.

Features and benefits

- Simple monitoring of lubrication points
- Menu-guided adjustments via 2 push buttons
- Pre-adjustable hysteresis
- Programmable parameters, password protected
- Reverse polarity protection of the supply voltage, excess voltage, override and short circuit protection are provided
- Compact housing with 320° pivot
- For standard and superior applications

Applications

- Marine, off-shore applications
- Wind, vehicle, steel and heavy industries

Technical data

Function principle Lubricant	Digital pressure switch oil and fluid grease NLGI 000–00, grease NLGI 1, 2
Operating temperature	–25 to +125 °C; –13 to +257 °F
Operating pressure	max. 600 bar; max. 8 700 psi 234-11145-5: max. 400 bar; max. 5 800 psi
Operating voltage	18–36 VDC
Operating current	max. 500 mA
Current draw	≤ 50 mA
Output signal	1 or 2 × PNP; 1 analog, digital, NO or NC adjustable
Switching frequency	max. 200 Hz
Switching point adjusted	234-11145-5: 175 bar; 2 465 psi
Material:	
Housing	PA6.6, stainless steel, FKM
Measuring cell	ceramics Al2O3
Adapter	stainless steel
Electrical connection	M12 × 1; 4 pin plug
Pressure port	G 1/4 or G 3/8; DIN3852
Protection class	IP 67; EC 60529
Dimensions	min. 34 × 94 × 49 mm max. 34 × 134,5 × 49 mm min. 1.34 × 3.7 × 1.9 in max. 1.34 × 5.3 × 1.9 in
Mounting position	any

Order information

Order number	Designation
234-11145-3	1 × PNP, 4–20 MA, with adapter G 1/4 and connector
234-11145-4	1 × PNP, 4–20 MA, basic model
234-11145-5	2 × PNP, 0–20 MA, with adapter G 1/4 and connector, front flushed
234-11145-9	1 × PNP, 4–20 MA, with adapter G 3/8 and connector



NOTE

Further technical information, technical drawings, accessories, spare parts or product function descriptions available on SKF.com/lubrication.

Monitoring devices

234-10825-8



Description

This pressure switch reliably monitors pressure in lubrication systems at a pre-adjusted pressure value. When adjusted value is reached, pressure switch opens or closes an electric circuit via a defined piston stroke (depending on pressure power and pre-load spring). A micro switch can be used for DC or AC voltage. The switch's housing can be pivoted up to 360°. The pre-adjusted switching point pressure value is set at the factory.

Features and benefits

- Simple, mechanically operated pressure switch for monitoring of lubrication points
- Designed as a change-over pressure switch
- Monitors a pre-adjusted pressure value
- Suitable for DC and AC voltage
- Pivotal housing up to 360°
- Maintenance free

Applications

- Machine tools
- Construction machinery
- Wind energy
- Vehicle
- Steel and heavy industries

Technical data

Order number	234-10825-8
Function principle	rotatable pressure switch
Lubricant	oil and fluid grease NLGI 000, 00
Operating temperature	-25 to +85 °C -13 to +185 °F
Operating pressure	max. 400 bar max. 5 800 psi
Switching pressure	100 to 400 bar 1 450 to 5 800 psi
Adjustability	under pressure
Operating voltage	adjustable: 30 to 250 VDC; 125; 250 VAC
Load resistance	0,25-5 A
Load inductive	0,25-5 A
Switch type	micro switch with spring-loaded piston
Contact type	change-over
Contact electrical	plug connector DIN72585 ø 2,5 mm
Material:	
Housing	zinc-coated steel, UR
Contact electrical	electroplated silver gilt
Protection class	IP 67, IP 6K9K
Dimensions	30 × 74 mm; 1.18 × 2.91 in
Mounting position	any, but preferably vertical



NOTE

Further technical information, technical drawings, accessories, spare parts or product function descriptions available on SKF.com/lubrication.

Index

24-0159-6021	149	161-210-012.....	27	223-12479-5.....	108
24-0159-6022	109	161-210-016.....	27	223-12479-5.....	109
24-0159-6022	113	161-210-021.....	24	223-12479-5.....	113
24-0159-6022	149	161-210-024.....	24	223-12485-8	108
24-0159-6023	99	161-210-030.....	27	223-13016-3.....	108
24-0159-6023	149	161-210-031.....	27	223-13016-3.....	109
24-0159-6024	109	161-210-032.....	27	223-13016-3.....	113
24-0159-6024	113	161-210-034.....	24	223-13021-1.....	108
24-0159-6024	114	161-210-036.....	24	223-13021-1.....	109
24-0159-6024	116	161-210-040.....	27	223-13021-1.....	113
24-0159-6024	118	161-210-041.....	27	223-13021-3.....	108
24-0159-6024	149	161-210-042.....	27	223-13048-1.....	108
24-0159-6025	149	161-210-061.....	24	223-13048-5	112
24-0159-6026	149	161-210-062.....	24	223-13052-1.....	83
24-0159-6028	99	161-210-063.....	24	223-13052-2.....	83
24-0159-6028	149	161-210-065.....	24	223-13052-2.....	95
24-2151-3734.....	118	161-210-066.....	24	223-13052-2.....	105
24-2151-3736.....	118	169-000-146.....	81	223-13052-3.....	83
24-2151-3760.....	114	169-000-171.....	25	223-13052-3.....	95
24-2151-3760.....	116	169-000-174.....	25	223-13052-3.....	105
24-2151-3762.....	114	169-140-001.....	51	223-13052-5.....	95
24-2151-3762.....	116	179-990-486.....	133	223-13052-5.....	105
24-2151-3764.....	114	219-13798-3.....	92	223-13069-1.....	109
24-2151-3764.....	116	219-13798-3.....	102	223-13069-1.....	113
24-2583-2516	150	220-12238-9	95	223-13621-9.....	127
24-2583-2517.....	150	223-10263-8	108	223-13658-2	127
24-2583-2526	150	223-10263-8	109	223-13658-8	127
24-9909-0241	25	223-10263-8	113	223-14129-4.....	112
24-9909-0244	25	223-10814-2.....	127	223-14129-4.....	112
24-9909-0244	63	223-12270-8	109	223-14240-5.....	112
24-9909-0244	73	223-12270-8	113	226-10337-3.....	99
24-9909-0244	85	223-12270-9.....	108	226-11169-1.....	147
44-2578-6110.....	97	223-12270-9.....	109	226-13756-9.....	127
44-2578-6201.....	97	223-12270-9.....	113	226-14091-2.....	92
44-2578-6321.....	97	223-12272-9.....	112	226-14091-2.....	102
44-2578-6323.....	97	223-12284-7.....	112	226-14091-4.....	29
44-2578-6350	97	223-12362-4	108	226-14091-4.....	31
44-2578-6360	97	223-12369-9	112	226-14091-4.....	33
96-1108-0058	150	223-12477-6.....	112	226-14091-4.....	35
161-210-012.....	24	223-12477-9.....	112	226-14091-4.....	37

Index

226-14091-4.....	92	235-14343-3.....	17	303-16119-1.....	95
226-14091-4.....	102	235-14343-3.....	21	303-16120-1.....	91
226-14091-5.....	89	235-14343-4.....	17	303-16120-1.....	95
226-14091-6.....	92	235-14343-4.....	21	303-16121-1.....	91
226-14091-6.....	102	235-14343-4.....	41	303-16121-1.....	95
226-14091-8.....	92	235-14343-5.....	17	303-16122-1.....	91
226-14091-8.....	102	235-14343-5.....	21	303-16122-1.....	95
226-14091-9.....	92	235-14343-5.....	41	303-16123-1.....	91
226-14091-9.....	102	235-14343-7.....	17	303-16123-1.....	95
226-14105-5.....	17	235-14343-7.....	21	303-16124-1.....	91
226-14105-5.....	21	236-10022-7.....	93	303-16124-1.....	95
226-14111-1.....	127	236-10022-7.....	103	303-16125-1.....	91
226-14160-3.....	127	236-10153-3.....	147	303-16125-1.....	95
233-10765-3.....	16	236-10280-6.....	17	303-16126-1.....	91
233-10765-3.....	20	236-10280-6.....	21	303-16126-1.....	95
233-10765-3.....	41	236-10567-5.....	131	303-16127-1.....	91
234-10151-8.....	148	236-10567-6.....	131	303-16127-1.....	95
234-10151-9.....	148	236-10850-7.....	133	303-16284-1.....	89
234-10812-8.....	93	236-10850-8.....	133	303-16470-1.....	95
234-10812-8.....	103	236-10850-9.....	133	303-17499-3.....	29
234-10825-8.....	145	236-10980-6.....	133	303-17499-3.....	31
234-10825-8.....	153	236-10986-1.....	147	303-17499-3.....	33
234-11145-3.....	152	236-11066-1.....	133	303-17499-3.....	35
234-11145-4.....	152	236-11335-8.....	143	303-17499-3.....	37
234-11145-5.....	152	236-13281-2.....	93	303-17499-3.....	61
234-11145-9.....	152	236-13281-2.....	103	303-17499-3.....	77
234-11454-1.....	93	237-13321-8.....	16	303-17499-3.....	79
234-11454-1.....	103	237-13321-8.....	20	303-17499-3.....	92
234-11454-1.....	149	237-13321-8.....	41	303-17499-3.....	102
234-13134-5.....	93	237-13426-1.....	16	303-19285-1.....	13
234-13134-5.....	103	237-13426-1.....	20	303-19346-2.....	92
234-13163-9.....	93	237-13442-4.....	93	303-19346-2.....	102
234-13163-9.....	103	237-13442-4.....	103	304-16543-1.....	16
234-13163-9.....	149	237-13442-4.....	149	304-16543-1.....	20
235-14343-1.....	17	237-13442-6.....	93	304-16543-1.....	40
235-14343-1.....	21	237-13442-6.....	103	304-17571-1.....	13
235-14343-1.....	41	244-14164-1.....	79	304-17574-1.....	13
235-14343-2.....	17	303-16118-1.....	91	307-19543-1.....	103
235-14343-2.....	21	303-16118-1.....	95	307-19543-1.....	103
235-14343-2.....	41	303-16119-1.....	91	307-19644-1.....	16

Index

307-19644-1.....	20	445-531-062.....	108	504-102-VS.....	109
404-006-VS.....	109	445-531-062.....	109	504-102-VS.....	113
404-006-VS.....	113	445-531-062.....	113	504-108-VS.....	109
404-040-VS.....	109	445-535-101.....	112	504-108-VS.....	113
404-040-VS.....	113	449-70906-1.....	93	504-30344-4.....	29
404-22614-1.....	93	451-004-518-VS.....	109	504-30344-4.....	31
404-22614-1.....	103	451-004-518-VS.....	113	504-30344-4.....	33
406-004-VS.....	108	451-006-518-VS.....	108	504-30344-4.....	35
406-004-VS.....	109	451-006-518-VS.....	109	504-30344-4.....	37
406-004-VS.....	113	451-006-518-VS.....	113	504-30344-4.....	61
406-054-VS.....	112	455-431-068-VS.....	108	504-30344-4.....	77
406-411.....	150	455-531-048-VS.....	109	504-30344-4.....	79
406-413W.....	112	455-531-048-VS.....	113	504-30344-4.....	92
406-423W.....	108	456-004-VS.....	109	504-30344-4.....	102
406-423W-VS.....	108	456-004-VS.....	113	504-30345-2.....	61
406-423W-VS.....	109	456-004-VS.....	127	504-30345-2.....	77
406-423W-VS.....	113	466-419-001.....	97	504-30345-2.....	79
408-413.....	112	466-419-001.....	99	504-30345-2.....	92
408-423W-S3.....	127	466-419-001.....	114	504-30345-2.....	102
408-425W.....	108	466-419-001.....	116	504-30698-1.....	16
410-405.....	112	466-431-001.....	97	504-30698-1.....	20
410-443W.....	108	466-431-001.....	99	504-30698-1.....	40
410-443W.....	109	471-004-191.....	109	504-31705-1.....	92
410-443W.....	113	471-004-191.....	113	504-31705-1.....	102
412-423.....	112	471-004-311.....	109	504-31709-1.....	92
419-22603-4.....	89	471-004-311.....	113	504-31709-1.....	102
419-22604-2.....	89	471-006-161.....	112	504-31863-1.....	92
419-74031-1.....	93	471-06-192.....	108	504-31863-1.....	102
419-74031-1.....	103	471-006-192.....	109	504-31864-1.....	92
441-008-511.....	108	471-006-192.....	113	504-31864-1.....	102
441-008-511.....	109	471-006-192.....	127	504-32125-1.....	16
441-008-511.....	113	471-006-311.....	108	504-32125-1.....	20
445-431-068-VS.....	109	471-006-311.....	109	504-32125-1.....	41
445-431-068-VS.....	113	471-006-311.....	113	504-33659-1.....	95
445-516-061.....	112	471-006-351.....	112	504-33659-1.....	105
445-519-041.....	109	471-008-161.....	112	504-33660-1.....	95
445-519-041.....	113	471-008-351.....	112	504-33660-1.....	105
445-531-061.....	108	471-010-161.....	112	504-33661-1.....	95
445-531-061.....	109	471-010-351.....	112	504-33661-1.....	105
445-531-061.....	113	471-012-161.....	112	504-36071-5.....	16

Index

504-36071-5.....	20	532-34839-3	147	549-34254-4.....	35
504-36071-5.....	40	532-34839-5	147	549-34254-4.....	91
504-36071-6.....	16	532-34839-6	147	549-34254-4.....	95
504-36071-6.....	20	532-37731-1.....	147	549-34254-5	35
504-36071-6.....	40	532-60073-1.....	93	549-34254-5	91
504-36071-7.....	16	532-60073-1.....	103	549-34254-5	95
504-36071-7.....	20	532-60075-1.....	93	549-34254-6	91
504-36071-7.....	41	532-60075-1.....	103	549-34254-6	95
506-108-VS	108	532-60085-1	93	549-34254-7.....	91
506-108-VS	109	532-60085-1	103	549-34254-7.....	95
506-108-VS	113	540-31800-1	16	549-34254-8	91
506-108-VS	127	540-31800-1	20	549-34254-8	95
506-140-VS	108	540-31800-1	41	549-34254-9	91
506-140-VS	109	540-36753-5.....	16	549-34254-9	95
506-140-VS	113	540-36753-5.....	20	549-34255-1.....	91
506-510-VS	108	540-36753-5.....	41	549-34255-1.....	95
506-511-VS.....	108	544-32022-1.....	16	549-34255-2 ²⁾	95
508-108.....	118	544-32022-1.....	20	600-26875-2	13
519-30911-1.....	93	544-32023-1.....	16	600-26875-2	16
519-30911-1.....	103	544-32023-1.....	20	600-26875-2	20
519-31661-1.....	89	544-32787-1.....	16	600-26875-2	40
519-31826-1.....	92	544-32787-1.....	20	600-26876-2	13
519-31826-1.....	102	544-32788-1.....	16	600-26876-2	16
519-34271-1.....	103	544-32788-1.....	20	600-26876-2	20
519-34271-1.....	103	544-32850-1.....	17	600-26876-2	40
519-34643-1.....	95	544-32850-1.....	21	600-26877-2	13
519-34643-1.....	105	544-33843-1.....	17	600-26877-2	16
519-34643-2.....	95	544-33843-1.....	21	600-26877-2	20
519-34643-2.....	105	544-36961-1.....	16	600-26877-2	40
519-34643-3.....	95	544-36961-1.....	20	600-28750-1	16
519-34643-3.....	105	544-36961-1.....	41	600-28750-1	20
519-34643-4.....	95	549-34254-1.....	35	600-28750-1	40
519-34643-4.....	105	549-34254-1.....	91	600-29185-1	16
519-36713-7.....	93	549-34254-1.....	95	600-29185-1	20
519-36713-7.....	103	549-34254-2	35	600-29185-1	40
519-85224-1.....	149	549-34254-2	91	600-29303-1	16
524-32231-1.....	17	549-34254-2.....	95	600-29303-1	20
524-32231-1.....	21	549-34254-3	35	600-29303-1	40
524-32231-1.....	41	549-34254-3	91	600-29304-1	16
532-34839-2	147	549-34254-3	95	600-29304-1	20

Index

600-29304-1	40	619-26653-1	89	619-28257-1	101
600-29305-1	16	619-26654-3	89	619-28258-1	101
600-29305-1	20	619-26761-1	89	619-28259-1	101
600-29305-1	40	619-26762-3	89	619-28260-1	101
600-78018-1	16	619-26764-1	89	619-28862-1	101
600-78018-1	20	619-26765-3	89	619-28863-1	101
600-78018-1	40	619-26841-1	101	619-28864-1	101
603-41200-1	83	619-26842-2	101	619-28865-1	101
603-41200-2	83	619-26844-1	101	619-28866-1	101
603-41200-3	83	619-26845-2	101	619-28871-1	101
603-41200-4	83	619-26846-1	89	619-28872-1	101
604-25102-1	77	619-26847-2	89	619-28873-1	101
604-25103-1	77	619-26848-1	89	619-28874-1	101
604-25105-2	61	619-26849-3	89	619-28875-1	101
604-25108-2	77	619-27121-1	101	619-28890-1	101
604-25109-2	77	619-27122-1	101	619-28899-1	101
604-25111-3	61	619-27471-1	101	619-28900-1	101
604-25128-2	77	619-27472-1	101	619-28901-1	101
604-25130-3	61	619-27473-1	101	619-28902-1	101
604-28766-1	79	619-27474-1	101	619-28905-1	101
604-28767-1	79	619-27475-1	101	619-28907-1	101
604-28768-1	79	619-27476-1	101	619-28934-1	101
604-28769-1	79	619-27477-1	101	619-28935-1	101
604-29967-1	61	619-27478-1	101	619-28957-1	101
604-29968-1	61	619-27613-1	101	619-28959-1	101
604-29969-1	61	619-27614-1	101	619-29015-1	101
604-36879-1	93	619-27615-1	101	619-29028-1	101
604-36879-1	103	619-27616-1	101	619-29050-1	101
619-25730-2	101	619-27792-1	101	619-29051-1	101
619-25731-2	101	619-27793-1	101	619-29052-1	101
619-25754-4	101	619-27796-1	101	619-29063-1	101
619-25755-4	101	619-27797-1	101	619-29064-1	101
619-26396-2	101	619-27800-1	101	619-29065-1	101
619-26398-2	101	619-27801-1	101	619-29066-1	101
619-26473-1	101	619-27804-1	101	619-29067-1	101
619-26474-3	101	619-27805-1	101	619-29068-1	101
619-26646-2	101	619-27824-1	101	619-29069-1	101
619-26648-2	101	619-27825-1	101	619-29074-1	101
619-26650-1	89	619-27889-1	101	619-29139-1	101
619-26651-3	89	619-27900-1	101	619-29322-1	101

Index

619-29387-1.....	101	619-77828-1.....	101	645-29873-1.....	43
619-29400-1.....	101	619-77829-1.....	101	645-29873-1.....	45
619-29401-1.....	101	619-77910-1.....	101	645-29873-1.....	47
619-29674-1.....	101	624-28858-1.....	17	645-77196-1.....	43
619-29775-1.....	101	624-28858-1.....	21	645-77196-1.....	45
619-29929-1.....	101	624-28859-1.....	17	645-77196-1.....	47
619-29951-1.....	101	624-28859-1.....	21	645-77625-1.....	43
619-29970-1.....	101	624-28860-1.....	17	645-77625-1.....	45
619-29971-1.....	101	624-28860-1.....	21	645-77625-1.....	47
619-29973-1.....	101	624-28861-1.....	17	645-77734-1.....	43
619-29993-1.....	101	624-28861-1.....	21	645-77734-1.....	45
619-29994-1.....	101	624-28867-1.....	17	645-77734-1.....	47
619-37044-1.....	89	624-28867-1.....	21	649-29485-1.....	91
619-37045-3.....	89	624-28891-1.....	17	649-29486-1.....	91
619-37049-1.....	89	624-28891-1.....	21	649-29487-1.....	91
619-37050-3.....	89	624-28892-1.....	41	649-29488-1.....	91
619-77101-1.....	101	624-28893-1.....	41	649-29489-1.....	91
619-77178-1.....	101	624-28894-1.....	17	649-29495-1.....	91
619-77179-1.....	101	624-28894-1.....	21	649-29496-1.....	91
619-77254-1.....	101	624-28895-1.....	17	649-29497-1.....	91
619-77301-1.....	101	624-28895-1.....	21	649-29498-1.....	91
619-77345-1.....	101	624-28896-1.....	17	649-29499-1.....	91
619-77346-1.....	101	624-28896-1.....	21	649-29505-1.....	91
619-77347-1.....	101	624-28897-1.....	17	649-29506-1.....	91
619-77348-1.....	101	624-28897-1.....	21	649-29507-1.....	91
619-77349-1.....	101	624-28931-1.....	17	649-29508-1.....	91
619-77350-1.....	101	624-28931-1.....	21	649-29509-1.....	91
619-77351-1.....	101	624-29054-1.....	13	649-29515-1.....	91
619-77352-1.....	101	624-29054-1.....	43	649-29516-1.....	91
619-77353-1.....	101	624-29054-1.....	45	649-29517-1.....	91
619-77461-1.....	101	624-29054-1.....	47	649-29518-1.....	91
619-77680-1.....	101	624-29056-1.....	13	649-29519-1.....	91
619-77681-1.....	101	624-29056-1.....	43	649-29525-1.....	91
619-77682-1.....	101	624-29056-1.....	45	649-29526-1.....	91
619-77683-1.....	101	624-29056-1.....	47	649-29527-1.....	91
619-77684-1.....	101	624-29087-1.....	17	649-29528-1.....	91
619-77685-1.....	101	624-29087-1.....	21	649-29529-1.....	91
619-77686-1.....	101	624-29087-1.....	41	649-29535-1.....	91
619-77687-1.....	101	624-29426-1.....	17	649-29536-1.....	91
619-77688-1.....	101	624-29426-1.....	21	649-29537-1.....	91

Index

649-29538-1	91	649-29621-1	91	649-77188-1	91
649-29539-1	91	649-29622-1	91	649-77394-1	91
649-29545-1	91	649-29627-1	91	649-77395-1	91
649-29546-1	91	649-29628-1	91	649-77396-1	91
649-29547-1	91	649-29629-1	91	649-77397-1	91
649-29548-1	91	649-29630-1	91	649-77398-1	91
649-29549-1	91	649-29635-1	91	649-77399-1	91
649-29555-1	91	649-29636-1	91	649-77400-1	91
649-29556-1	91	649-29637-1	91	649-77401-1	91
649-29557-1	91	649-29638-1	91	649-77402-1	91
649-29558-1	91	649-29643-1	91	649-77464-1	95
649-29559-1	91	649-29644-1	91	649-77464-1	105
649-29565-1	91	649-29645-1	91	649-77466-1	95
649-29566-1	91	649-29646-1	91	649-77466-1	105
649-29567-1	91	649-29651-1	91	649-77468-1	95
649-29568-1	91	649-29652-1	91	649-77468-1	105
649-29569-1	91	649-29653-1	91	649-77470-1	95
649-29575-1	91	649-29654-1	91	649-77470-1	105
649-29576-1	91	649-29659-1	91	649-77472-1	95
649-29577-1	91	649-29660-1	91	649-77472-1	105
649-29578-1	91	649-29661-1	91	649-77474-1	95
649-29579-1	91	649-29662-1	91	649-77474-1	105
649-29587-1	91	649-77167-1	95	649-77475-1	95
649-29588-1	91	649-77167-1	105	649-77475-1	105
649-29589-1	91	649-77168-1	95	649-77476-1	95
649-29590-1	91	649-77168-1	105	649-77476-1	105
649-29595-1	91	649-77169-1	95	649-77477-1	95
649-29596-1	91	649-77169-1	105	649-77477-1	105
649-29597-1	91	649-77170-1	95	649-77478-1	95
649-29598-1	91	649-77170-1	105	649-77478-1	105
649-29603-1	91	649-77171-1	95	649-77852-1	91
649-29604-1	91	649-77171-1	105	649-77853-1	91
649-29605-1	91	649-77180-1	91	649-77854-1	91
649-29606-1	91	649-77181-1	91	649-77855-1	91
649-29611-1	91	649-77182-1	91	649-77856-1	91
649-29612-1	91	649-77183-1	91	649-77857-1	91
649-29613-1	91	649-77184-1	91	649-77858-1	91
649-29614-1	91	649-77185-1	91	649-77859-1	91
649-29619-1	91	649-77186-1	91	649-77860-1	91
649-29620-1	91	649-77187-1	91	650-28856-1	29

Index

650-28856-1	31	664-36862-8	17	2230-00000034.....	127
650-28856-1	33	664-36862-8	21	2230-00000035.....	127
650-28856-1	35	664-85046-3	51	2260-00000020.....	127
650-28856-1	37	664-85242-2	93	3515-07-2022	133
655-28716-1.....	13	664-85242-2	103	3515-07-6120.....	133
655-28716-1.....	16	664-85242-5	93	3515-10-2021.....	133
655-28716-1.....	20	664-85242-5	103	3515-10-6020	133
655-28716-1.....	40	664-85282-6	93	3515-10-6120.....	133
664-34045-1.....	29	664-85282-6	103	3515-10-6320	133
664-34045-1.....	31	664-85282-7	93	3515-10-6620	133
664-34045-1.....	33	664-85282-7	103	3515-10-7620.....	133
664-34045-1.....	35	664-85282-8	93	67359.....	125
664-34045-1.....	37	664-85282-8	103	68645.....	121
664-34135-7.....	134	664-85388-8	17	68645.....	123
664-34167-2.....	17	664-85388-8	21	84239.....	75
664-34167-2.....	21	664-85388-9	17	086500	132
664-34167-6.....	17	664-85388-9	21	086501	132
664-34167-6.....	21	664-85388-9	41	086502	132
664-34167-9.....	17	664-85421-9.....	17	086503	132
664-34167-9.....	21	664-85421-9.....	21	086504	133
664-34428-3	17	857-760-002.....	63	086505	133
664-34428-3	21	857-760-002.....	73	086506	133
664-36078-7.....	17	857-760-002.....	85	086507.....	133
664-36078-7.....	21	857-760-007.....	25	86535.....	130
664-36078-7.....	29	857-760-007.....	63	87026-03S	125
664-36078-7.....	31	857-760-007.....	73	87026-03T	125
664-36078-7.....	33	857-760-007.....	85	87026-05S	125
664-36078-7.....	35	857-870-002	25	87026-05T	125
664-36078-7.....	37	917-006-101.....	81	87026-08S	125
664-36078-9	17	995-001-500	25	87026-08T	125
664-36078-9	21	995-001-500	63	87026-10S	125
664-36078-9	29	995-001-500	73	87026-10T	125
664-36078-9	31	995-001-500	85	87026-12S	125
664-36078-9	33	997-000-185	135	87026-12T.....	125
664-36078-9	35	997-000-630	27	87026-15S	125
664-36078-9	37	997-000-650	27	87026-15T.....	125
664-36862-1	17	997-000-820	27	87030-3.....	125
664-36862-1	21	1110-00000007	147	87030-4.....	125
664-36862-2	17	2230-00000032.....	127	87030-6.....	125
664-36862-2	21	2230-00000033.....	127	87200.....	59

Index

87202.....	69	87895.....	123	87942.....	125
87204.....	69	87896.....	123	87955.....	123
87212.....	67	87897.....	123	87955.....	123
87214.....	57	87905.....	121	87955.....	123
87216.....	59	87905.....	123	87955.....	123
87216.....	59	87918.....	121	87955.....	123
87218.....	59	87918.....	121	87955.....	123
87218.....	69	87918.....	121	87956.....	123
87400.....	59	87918.....	121	87956.....	123
87400.....	69	87918.....	121	87956.....	123
87402.....	57	87918.....	121	87956.....	123
87402.....	67	87919.....	121	87956.....	123
87403.....	57	87919.....	121	87956.....	123
87403.....	67	87919.....	121	87957.....	123
87405.....	57	87919.....	121	87957.....	123
87405.....	67	87919.....	121	87957.....	123
87406.....	59	87919.....	121	87957.....	123
87406.....	69	87920.....	121	87957.....	123
87413.....	59	87920.....	121	87957.....	123
87413.....	69	87920.....	121	130067.....	75
87416.....	59	87920.....	121	130179.....	59
87416.....	69	87920.....	121	130179.....	59
87417.....	59	87920.....	121	130200DEE.....	75
87417.....	69	87934.....	121	130200GEE.....	75
87418.....	59	87934.....	125	130201BCC.....	75
87418.....	69	87935.....	121	130300GEE.....	75
87419.....	59	87935.....	125	130332.....	75
87419.....	69	87936.....	121	130335.....	75
87421.....	59	87936.....	125	236640.....	123
87421.....	69	87937.....	121	236641.....	123
87423.....	59	87937.....	125	236642.....	123
87423.....	69	87938.....	121	236644.....	123
87823.....	125	87938.....	125	236645.....	123
87824.....	125	87939.....	121	236646.....	123
87862.....	75	87939.....	125	250290.....	121
87885.....	123	87940.....	121	250291.....	121
87886.....	123	87940.....	125	250292.....	121
87887.....	123	87941.....	121	250293.....	121
87888.....	123	87941.....	125	250294.....	121
87889.....	123	87942.....	121	250295.....	121

Index

876061.....	123	882403	121	IG 502-2-E+912	135
876062.....	123	882404	121	IG 502-2-E+924	135
876091.....	123	11500610.....	138	IGZ 51-20-E+471.....	137
876092.....	123	11500612.....	138	IGZ 51-20-E+472.....	137
876121	123	12375010.....	53	IGZ 51-20-S2-E+471	137
876122	123	12375050.....	53	IGZ 51-20-S2-E+472	137
876123	123	12375090.....	53	IGZ 51-20-S7-E+471	137
876124	123	12375130.....	53	IGZ 51-20-S7-E+472	137
876181	123	12375170.....	53	IGZ 51-20-S8-E+471	137
876182.....	123	12375210.....	53	IGZ 51-20-S8-E+472	137
876183.....	123	12380200	139	KFA1+912.....	27
876184.....	123	12380760.....	141	KFA1+924.....	27
876241.....	123	12380765.....	141	KFA1-M+924	27
876242.....	123	12381280.....	53	KFA1-M-W+924	27
876243.....	123	12381285.....	53	KFA1.U1	27
876244.....	123	12381290.....	53	KFA1.U2	27
882051.....	121	12381292.....	53	KFA1.U3	27
882052	121	12381294.....	53	KFA1-W+912.....	27
882101.....	121	12381296.....	53	KFA1-W+924.....	27
882102.....	121	12381381.....	65	KFAS1+912.....	27
882151.....	121	12381382.....	65	KFAS1+924.....	27
882152.....	121	12381383.....	65	KFAS1-M+924	27
882201	121	12381384.....	65	KFAS1-M-W+924	27
882202	121	12381385.....	65	KFAS1-M-W-Z+924	27
882203	121	12381386.....	65	KFAS1-M-Z+924	27
882204	121	12381700.....	65	KFAS1-W+912	27
882251.....	121	12381701.....	65	KFAS1-W+924	27
882252.....	121	12381702.....	65	KFAS10+485	27
882253	121	12382666	65	KFAS10-W+485.....	27
882254	121	12501270.....	141	KFG 1.U0.....	24
882301	121	DIN908-R1-4-5.8	118	KFG 1.U0-E	24
882302	121	DSB1-S30000X-1A-01	51	KFG 1.U1.....	24
882303	121	EWT2A01-S1-E+471	151	KFG 1.U1-E.....	24
882304	121	EWT2A01-S1-E+472	151	KFG 1.U2.....	24
882351.....	121	EWT2A04-S1-E+471	151	KFG 1.U2-E	24
882352.....	121	EWT2A04-S1-E+472	151	KFG 1.U3.....	24
882353	121	EXZT2A03-E+471	137	KFG 1.U3-E	24
882354	121	EXZT2A03-E+472	137	KFG 1.U4.....	24
882401.....	121	EXZT2A06-E+471	137	LRM2-E-00-100.....	143
882402	121	EXZT2A06-E+472	137	MCLP	11

Index

PF-23-2.....	85	PPU-BS160.....	55
PF-23-22.....	85	PPU-BS160.....	71
PFH-23-2.....	73	PPU-BS180.....	55
PFH-23-22.....	73	PPU-BS180.....	71
PFP-23-2.....	63	QLS 311 SSV.....	9
PFP-23-22.....	63	VPBG-C2.....	99
PF-VPBM-3-2.....	81	VPBG-C3.....	99
PF-VPBM-4-2.....	81	VPBG-C4.....	99
PF-VPBM-5-2.....	81	VPBM-C2.....	99
PF-VPBM-6-2.....	81	VPBM-C3.....	99
PHU-5.....	71	VPBM-C4.....	99
PHU-5-2.5.....	71	VP-C.....	113
PHU-5-2.5W.....	71	VPG-C.....	113
PHU-5-5.....	71	VPG-RV.....	113
PHU-5-5W.....	71	VPG-RV6.....	113
PHU-35.....	71	VPG-RV8.....	113
PHU-35-2.5.....	71	VPKG-RV.....	99
PHU-35-2.5W.....	71	VPKG-RV.....	109
PHU-35-5.....	71	VPKG-RV4-VS.....	99
PHU-35-5W.....	71	VPKG-RV-VS.....	99
PPU-5.....	55	VPKM-RV-S4.....	81
PPU-5-2.5.....	55	VPKM-RV-S4.....	99
PPU-5-2.5W.....	55	VPKM-RV-S4.....	109
PPU-5-5.....	55	VPKM-RV-VS.....	81
PPU-5-5W.....	55	VPKM-RV-VS.....	99
PPU-35.....	55	VPKM-RV-VS.....	109
PPU-35-2.5.....	55	VPM-RV.....	113
PPU-35-2.5W.....	55	VPM-RV4.....	113
PPU-35-5.....	55	VPM-RV8.....	113
PPU-35-5W.....	55	VPM-RV10.....	113
PPU-BS60.....	55		
PPU-BS60.....	71		
PPU-BS80.....	55		
PPU-BS80.....	71		
PPU-BS100.....	55		
PPU-BS100.....	71		
PPU-BS120.....	55		
PPU-BS120.....	71		
PPU-BS140.....	55		
PPU-BS140.....	71		



Important information on product usage

SKF and Lincoln lubrication systems or their components are not approved for use with gases, liquefied gases, pressurized gases in solution and fluids with a vapor pressure exceeding normal atmospheric pressure (1 013 mbar) by more than 0,5 bar at their maximum permissible temperature.



skf.com | skf.com/lubrication | lincolnindustrial.com

© SKF and LINCOLN are registered trademarks of the SKF Group.

© SKF Group 2020

The contents of this publication are the copyright of the publisher and may not be reproduced (even extracts) unless prior written permission is granted. Every care has been taken to ensure the accuracy of the information contained in this publication but no liability can be accepted for any loss or damage whether direct, indirect or consequential arising out of the use of the information contained herein.

PUB LS/P1 16964 EN · June 2020

Certain image(s) used under license from Shutterstock.com